

RISAT-1 Data Products Formats (August 2014)

**Advanced Image Processing Division
Data Products Software Group
Signal and Image Processing Area
Space Applications Centre
Ahmedabad**

Format Document Version 1.3

Following is the list of updates in this version of format document:

1. RCS (σ) Calculations for Point Targets

Equation for Computation of Radar Cross Section (σ) (Equation 2.1) for Point Targets has been modified as mentioned in section 2.1.

2. Calibration Constant for Sigma0 (σ_0), Gamma0 (γ_0) and Beta0(β_0)

Calibration Constant is being provided in RISAT-1 Data Products for computation of Sigma0. For the products generated with software version 1.3.01 onwards, Calibration Constant will also be provided for computing Gamma0 and Beta0 as per following format:

2.1 BAND_META.txt file

Tag:	<i>Calibration_Constant_TxRx</i>	Calibration Constant for <i>Sigma0</i>
Tag:	<i>Calibration_Constant_Gamma0_TxRx</i>	Calibration Constant for <i>Gamma0</i>
Tag:	<i>Calibration_Constant_Beta0_TxRx</i>	Calibration Constant for <i>Beta0</i>

2.2 CEOS ::RADIOMETRIC DATA RECORD

Field:	<i>calib_const</i>	Calibration Constant for <i>Sigma0</i>
Field:	<i>calib_const_Gamma0</i>	Calibration Constant for <i>Gamma0</i>
Field:	<i>calib_const_Beta0</i>	Calibration Constant for <i>Beta0</i>

2.3 product.xml file (*only for Level-2 GeoTIFF products*)

	<i>polarization Wise</i>	
Tag:	calibrationConstant	Calibration Constant for Sigma0
Tag:	calibrationConstant_Gamma0	Calibration Constant for Gamma0
Tag:	calibrationConstant_Beta0	Calibration Constant for Beta0

Table of Contents

S.No.	Section	Title	Page No.
1.	1.0	RISAT-1 Data Products	1
2.	1.1	RISAT-1 Data Products Contents	2
3.	2.0	Radiometric Calibration of RISAT-1 Data Products	3
4.	Appendix-1	Format of RISAT-1 Band Meta File	6
5.	A1.0	Sample RISAT-1 Data Product BAND META File	7
6.	Appendix-2	RISAT-1 CEOS Record Structure and Contents	9
7.	A2.0	RISAT-1 CEOS Products and CEOS Format	10
8.	A2.0.1	Detailed Description of RISAT-1 CEOS Records	11
9.	A2.1	Volume Descriptor Record Contents	12
10.	A2.2	SAR Leader File Pointer Record	13
11.	A2.3	Image Options File Pointer Record Contents	14
12.	A2.4	Text Record Contents	15
13.	A2.5	SAR Leader File - File Descriptor Record Contents	16
14.	A2.6	Data Set Summary Record Contents	18
15.	A2.7	Data Quality Summary Record Contents	22
16.	A2.8	Data Histogram Record - Signal Data	23
17.	A2.9	Data Histogram Record - Processed Data (16-bit)	24
18.	A2.10	Detailed Processing Parameters Record Contents	26
19.	A2.11	Map Projection Data Record Contents	29
20.	A2.11.1	Polyconic Projection	31
21.	A2.12	Platform Position Data Record Contents	32
22.	A2.13	Attitude Data Record	33
23.	A2.14	Radiometric Data Record Contents	34
24.	A2.15	Radiometric Compensation Data Record	35
25.	A2.16	Image Options File Descriptor Record	36
26.	A2.17	Signal Data Record Contents	38
27.	A2.18	Processed Data Record	40
28.	A2.19	Null Volume Descriptor Record Contents	42
29.	A2.20	AUX Data Format	43
30.	Appendix-3	RISAT-1 GeoTIFF Record Structure and Contents	48
31.	A3.0	GeoTIFF Format	49
32.	A3.1	Product Information File Format	49
33.	A3.2	Importance of GeoTIFF	54
34.	A3.2.1	Structure of TIFF	55
35.	A3.3	GeoTIFF for RISAT-1 Data Products	56
36.	A3.3.1	GeoTIFF Structure	57
37.	A3.4	Validation of GeoTIFF Products	59
38.	Appendix-4	Scene Corner Coordinates Convention	60
39.		References	61
40.		Enquiries	62

1.0 RISAT-1 Data Products

RISAT-1 data products are available in following imaging modes:

- i) Fine Resolution STRIPMAP (**FRS-1**) mode
- ii) Fine Resolution Alternate Polarization STRIPMAP (**FRS-2**) mode
- iii) Medium Resolution SCANSAR (**MRS**) mode
- iv) Coarse Resolution SCANSAR (**CRS**) mode
- v) High Resolution SPOTLIGHT (**HRS**) mode

This document doesn't define the product levels and format structures applicable to HRS imaging mode.

The Level and type of RISAT-1 Data Products are listed in Table 1.1:

Img. Mode	RAW (CEOS)	L1-SLC (CEOS)	L1-Ground Range (CEOS)	L2- (CEOS & GeoTIFF)
FRS-1	✓	✓	✓	✓
FRS-2	✓	✓	NA	NA
MRS	✓	NA	✓	✓
CRS	✓	NA	✓	✓

✓ : Available

NA: Not Applicable

Table 1.1 Levels and type of RISAT-1 Data Products

Level-0: RAW Product

Level-1: Geo-Tagged Product

a) Level-1 **Single Look Complex (SLC); Slant Range** products

b) Level-1 **Ground Range** products

Level-2: Terrain Geo-Referenced Product

All levels of products are available in Single/Dual and Circular Polarizations (Table-1.2) for FRS1, MRS and CRS modes and in quad polarization for FRS2 mode.

Transmit Polarization(Tx)	Receive Polarization(Rx)	Mnemonic
Vertical	Vertical	VV
Vertical	Horizontal	VH
Horizontal	Vertical	HV
Horizontal	Horizontal	HH
Right Circular	Vertical	RV
Right Circular	Horizontal	RH
Left Circular	Vertical	LV
Left Circular	Horizontal	LH

Table 1.2 Polarization Combinations for RISAT-1 Products

1.1 RISAT-1 Data Products Contents

RISAT-1 data products for the user are identified with a unique work-order identity say WO_ID. For a particular data product following are the contents of WO_ID directory:

- i) **BAND_META.txt**
Ascii File having a listing of several product parameters (Appendix-1)
- ii) **Grid Files**
Image space is divided in a grid at the interval of N*N (e.g. 32*32) in scan and pixel direction; wherein first grid point corresponds to (0,0) in image space. The grid is listed in a text file along with the product in row major format. Attributes of the each grid point are latitude, longitude, slant range and incidence angle. Any of the above given attributes for any scan pixel position (s,p) can be calculated by interpolating the attributes from the neighbouring grid points.

Note: -9999.000000 is FLAG value in Level-2 product in case the pixel does not belong to imaged scene.

Product wise naming convention of Grid Files is as follows:

Level-0 RAW product: *There will be no grid files for RAW product.*

Level-1 SLC product: WO_ID_TxPolRxPol_L1_SlantRange_grid.txt
Ex: 128385331_HH_L1_SlantRange_grid.txt

Level-1 Ground Range product: WO_ID_TxPolRxPol_L1_GroundRange_grid.txt
Ex: 128385331_HH_L1_GroundRange_grid.txt

Level-2 product: WO_ID_TxPolRxPol_level_2_grid.txt
Ex: 128385331_HH_level_2_grid.txt

- iii) **Scene Files**
Scene Files are contained in the directory scene_TxPolRxPol.

For **CEOS product:** This directory contains four files namely vdf_dat.001, lea_01.001, dat_01.001 and nul_vdf.001 (Appendix-2).

For **Level-2 GeoTIFF product:** This directory contains one file namely imagery_TxpolRxpol.tif (Appendix-3).

- iv) **XML File**
A **product.xml** file (Appendix-3) with several product attributes is available only for the **Level-2 GeoTIFF** product.
- v) **Jpeg Files**
Thumbnail images (*not for RAW product*) of the scene imaged for the product are available in .jpg format with the following naming convention.
WO_ID_TxPol_RxPol.jpg
Ex: 128385331_HH.jpg

2.0 Radiometric Calibration of RISAT-1 Data Products

Radiometric calibration of the data is required to transform processed SAR data or images into measurements of Radar back scatter of targets. Depending upon the plane of measurement, radar backscatter coefficients can be classified as Sigma0 (σ_0), Gamma0 (γ_0) and Beta0 (β_0). The equations used for their computations are as follows:

Sigma0

$$\sigma_{0p} \text{ (dB)} = 20\log_{10} (\text{DN}_p) - K_{\text{cal_Sigma0 dB}} + 10\log_{10} (\text{Sin}(i_p)/\text{Sin}(i_{\text{center}})) \text{ ..(2.0)}$$

Gamma0

$$\sigma_{0p} \text{ (dB)} = \gamma_{0p} \text{ (dB)} + 10\log_{10} (\text{Cos}(i_p))$$

$$\begin{aligned} \gamma_{0p} \text{ (dB)} &= 20\log_{10} (\text{DN}_p) - K_{\text{cal_Gamma0 dB}} + 10\log_{10} (\text{Sin}(i_p)/\text{Sin}(i_{\text{center}})) \\ &+ 10\log_{10} (\text{Cos}(i_{\text{center}})/\text{Cos}(i_p)) \end{aligned} \text{ .. (2.1)}$$

Equivalently,

$$\gamma_{0p} \text{ (dB)} = 20\log_{10} (\text{DN}_p) - K_{\text{cal_Gamma0 dB}} + 10\log_{10} (\tan(i_p)/\tan(i_{\text{center}}))$$

$$K_{\text{cal_Gamma0 dB}} = K_{\text{cal_Sigma0 dB}} + 10\log_{10} (\text{Cos}(i_{\text{center}}))$$

Beta0

$$\sigma_{0p} \text{ (dB)} = \beta_{0p} \text{ (dB)} + 10\log_{10} (\text{Sin}(i_p))$$

$$\beta_{0p} \text{ (dB)} = 20\log_{10} (\text{DN}_p) - K_{\text{cal_Beta0 dB}} \text{ .. (2.2)}$$

$$K_{\text{cal_Beta0 dB}} = K_{\text{cal_Sigma0 dB}} + 10\log_{10} (\text{Sin}(i_{\text{center}}))$$

where,

σ_{0p} (dB) is the radar backscatter coefficient Sigma0 in dB for pixel p

γ_{0p} (dB) is the radar backscatter coefficient Gamma0 in dB for pixel p

β_{0p} (dB) is the radar backscatter coefficient Beta0 in dB for pixel p

DN_p is the digital number or the image pixel gray-level count for the pixel p

$K_{\text{cal_Sigma0 dB}}$ is the product calibration constant in dB for computing Sigma0

$K_{\text{cal_Gamma0 dB}}$ is the product calibration constant in dB for computing Gamma0

$K_{\text{cal_Beta0 dB}}$ is the product calibration constant in dB for computing Beta0

i_p is the incidence angle for the pixel position p

i_{center} is the incidence angle at the scene center

For computation of Sigma0, Gamma0 and Beta0 parameters required for equation (2.0), (2.1), (2.2) are extracted/computed as follows:

Digital Number (DN_p)

For the CEOS products Image pixel Digital Numbers can be extracted from field 53 pdr_data of the Processed Data Record (Section A2.18)

For SLC products: $DN_p = \text{Sqrt}(DNI_p^2 + DNQ_p^2)$

DNI_p :: DN Value of I component

DNQ_p :: DN Value of Q component

For the GeoTIFF products Image pixel Digital Numbers can be extracted from file imagery_TxPolRxPol.tif (Appendix-3)

Calibration Constant (K_{dB})

For the CEOS products Calibration Constants in dB can be extracted from field's calib_const, calib_const_Gamma0 & calib_const_Beta0 of the Radiometric Data Record (Section A2.14)

For the GeoTIFF products Calibration Constants in dB is available in the tags calibrationConstant, calibrationConstant_Gamma0, calibrationConstant_Beta0 in the product.xml file (Appendix-3)

Calibration Constants in dB are also available in tags Calibration_Constant_TxRx, Calibration_constant_Gamma0_TxRx & Calibration_Constant_Beta0_TxRx in the BAND_META.txt file.

Incidence Angle

For computing the incidence angle for any pixel position p incidence angle values in grid files along with product can be used. Computation can be made as per the write up under Grid Files in section 1.1. Scene Center incidence angle i_{center} can also be obtained directly from the IncidenceAngle field of BAND_META.txt file. For the CEOS products field 40 incident_ang of the Data Set summary Record (Section A2.6) also gives scene center incidence angle.

2.0.1 Corrections in Calibration Constant for RISAT-1 SLC products

Since, Calibration Constant to compute Sigma0 of Ground Targets provided for RISAT-1 SLC products generated on or before **(31/05/2013)** (*upto software version V 1.2.02*) is same as that provided for Multi-Look Ground Range products; depending on Imaging Mode and polarizations following correction in RISAT-1 SLC Product calibration Constant (K_{SLCdB}) is required.

Mode	Polarization	Correction
FRS-1	HH/HV/VV/VH	$K_{SLCdB} + 3.4629 \text{ dB}$
FRS-1	RH/RV	$K_{SLCdB} + 4.7629 \text{ dB}$

Table 2.1 Corrections in Calibration Constant for RISAT-1 SLC Products

However, for the SLC products generated by software version (V 1.2.03) after the date (31/05/2013) these correction factors are incorporated into the product Calibration Constant (K_{SLCdB}). Hence, the above correction factors needn't be applied.

2.1 RCS (σ) Calculations for Point Targets

For computing Sigma parameter i.e. σ and not the Sigma Naught parameter σ_0 , area of target has to be taken into account. Hence, the equation for σ is,

$$\sigma = 10 \log_{10} \left(\sum DN_w^2 \right) - K_{dB} + 10 \log_{10} \left(\frac{\sin(i_p)}{\sin(i_{center})} \right) + 10 \log_{10} (\text{Scattering Area}) \quad \dots\dots\dots (2.1)$$

where,

“w” is considered a window around Point Target over which return power is integrated e.g. (9X9, 11X11 ...)

“ i_p ” is the incidence angle at position of peak return of Point Target

Scattering Area = Azimuth Resolution X Slant Range Resolution

Azimuth Resoution and Slant Range Resolution can be obtained from **InputResolutionAlong** and **InputResolutionAcross** tags respectively of BAND_META.txt file.

Above equation holds true both for Single Look and Multilook data products.

Appendix-1

Format of RISAT-1 Band Meta File

A 1.0 Sample RISAT-1 Data Product BAND META File

ProductID=128399381
OTSPRODUCTID= //applicable dependent upon archival flag
SatID=RISAT-1
Sensor=SAR
GenAgency=NRSC / KSAT //Can be NRSC or KSAT
Path=0
Row=12
SessionNumber=1
SceneNumber=3
DateOfPass=09-JUN-2012
PassType=PLD
DateOfDump=09-JUN-2012
DumpingOrbitNo=665
ImagingOrbitNo=665
SamplesPerPixel=1
BitsPerSample=16
BytesPerPixel=2
GenerationDateTime=07-NOV-2012 18:11:59
ProdCode=STUC00GCV
ProductType=L2-GEOREF
InputResolutionAlong= 3.33 //Not Applicable for RAW product
InputResolutionAcross=2.34 //Not Applicable for RAW product
OutputLineSpacing=4.50 //Not Applicable for RAW product
OutputPixelSpacing=4.50 //Not Applicable for RAW product
ImageFormat=CEOS
ProcessingLevel=STD
ResampCode=CC //Not Applicable for RAW and SLC product
NoScans=8190
NoPixels=7212
MapProjection=UTM //Applicable only for Level-2 product
Ellipsoid=WGS_84 //Applicable only for Level-2 product
Datum=WGS_84 //Applicable only for Level-2 product
MapOriginLat=0.000000 //Applicable only for Level-2 product
MapOriginLon=81.000000 //Applicable only for Level-2 product
ProdULLat=21.453431
ProdULLon=78.905025
ProdURLat=21.457043
ProdURLon=79.216959
ProdLRLat=21.124440
ProdLRLon=79.220966
ProdLLLat=21.120888
ProdLLLon=78.909732
ProdULMapX=282900.345508 //Applicable only for Level-2 product
ProdULMapY=2373782.811108 //Applicable only for Level-2 product
ProdURMapX=315238.644930 //Applicable only for Level-2 product
ProdURMapY=2373782.811108 //Applicable only for Level-2 product
ProdLRMapX=315238.644930 //Applicable only for Level-2 product
ProdLRMapY=2336953.441762 //Applicable only for Level-2 product
ProdLLMapX=282900.345508 //Applicable only for Level-2 product
ProdLLMapY=2336953.441762 //Applicable only for Level-2 product
SceneCenterLat=21.289046
SceneCenterLon=79.063151
StandardParallel1=0.000000 //Applicable only for Level-2 product
FalseEasting=500000.000000 //Applicable only for Level-2 product
FalseNorthing=0.000000 //Applicable only for Level-2 product
ZoneNo=44 //Applicable only for Level-2 product
SceneStartTime=09-JUN-2012 00:30:54.530565471
SceneCenterTime=09-JUN-2012 00:30:56.830565471

SceneEndTime=09-JUN-2012 00:30:59.130565471
SceneCenterRoll=-36.00721740722656
SceneCenterPitch=0.06371075659990311
SceneCenterYaw=3.557820558547974
SunAzimuthAtCenter=68.66514587402344
SunElevationAtCenter=8.709013938903809
ImageHeadingAngle=191.596
IncidenceAngle= 25.39297
SatelliteAltitude=541.2949829101562
DEMCorrection=YES //Not Applicable for RAW and SLC product
DEMSource=CARTO-1/GTOPO // Not Applicable for RAW and SLC product
TerrainHeightApplied=TRUE_HEIGHT //Not Applicable for RAW & SLC product
SourceOfOrbit=2
SourceOfAttitude=1
ImagingDirection=F
EllipsoidSemiMajorAxis=6378137.0
EllipsoidSemiMinorAxis=6356752.3139897
EllipsoidEccentricity=0.0818191913
ImagingMode=FRS1
NoOfPolarizations=2
TxRxPol1=HV
TxRxPol2=HH
Node=DESCENDING
SensorOrientation=LEFT
NumberOfBeams=1
BeamNumber1=98
LookAngleBeamNumber1=-37.100
PRFBeamNumber1=2904.275
ProcessingNode=sac3
StationID=SAN
LineTimeDirectionIndicator=INCREASE
PixelTimeDirectionIndicator=INCREASE
ReplicaUsed=ACTUAL_REPLICA //Not Applicable for RAW product
Calibration_Constant_HV= 69.657
Calibration_Constant_HH= 72.861
ImageULLat=21.454165 //Significant for Level-2 Geo-Referenced Image
ImageULLon=78.964579 //Significant for Level-2 Geo-Referenced Image
ImageURLat=21.411669 //Significant for Level-2 Geo-Referenced Image
ImageURLon=79.217510 //Significant for Level-2 Geo-Referenced Image
ImageLRLat=21.123815 //Significant for Level-2 Geo-Referenced Image
ImageLRLon=79.162461 //Significant for Level-2 Geo-Referenced Image
ImageLLLat=21.166526 //Significant for Level-2 Geo-Referenced Image
ImageLLLon=78.909091 //Significant for Level-2 Geo-Referenced Image
ImageULMapX=289074.930270 //Applicable for Level-2 Geo-Referenced Image
ImageULMapY=2373782.811108 //Applicable for Level-2 Geo-Referenced Image
ImageURMapX=315238.644930 //Applicable for Level-2 Geo-Referenced Image
ImageURMapY=2368758.299791 //Applicable for Level-2 Geo-Referenced Image
ImageLRMapX=309160.345869 //Applicable for Level-2 Geo-Referenced Image
ImageLRMapY=2336953.441762 //Applicable for Level-2 Geo-Referenced Image
ImageLLMapX=282900.345508 //Applicable for Level-2 Geo-Referenced Image
ImageLLMapY=2342007.796126 //Applicable for Level-2 Geo-Referenced Image
RangeLooks=1.000
AzimuthLooks=2.000
Maximum_Expected_Geo_Location_Error=//Applicable for Level-2 Geo-Referenced Image
Maximum_Expected_Internal_Distortion=//Applicable for Level-2 Geo-Referenced Image
Calibration_Constant_Gamma0_HV=69.215
Calibration_Constant_Gamma0_HH=72.420
Calibration_Constant_Beta0_HV=65.981
Calibration_Constant_Beta0_HH=69.185
Remarks=Ok //Remarks based upon data processing

Appendix-2

RISAT-1 CEOS RECORD STRUCTURE AND CONTENTS

A2.0 RISAT-1 CEOS Products and CEOS Format

A CEOS product consists of four files containing various descriptive records. The files are as follows:

- Volume Directory file: vdf_dat.001
- SAR Leader file: lea_01.001
- SAR Data file: dat_01.001
- Null Volume Directory file: nul_vdf.001

Table A2.0 shows the general organization of the various CEOS files for RISAT products

CEOS FORMAT FILES / RECORDS	RISAT CEOS PRODUCTS			
	RAW	Level-1 Geo Tagged	Level-2 Terrain Geo- Referenced	Value Added Products
VOLUME DIRECTORY FILE				
• VOLUME DESCRIPTOR	<input checked="" type="checkbox"/>	<input checked="" type="checkbox"/>	<input checked="" type="checkbox"/>	<input checked="" type="checkbox"/>
• 2 FILE POINTER RECORDS	<input checked="" type="checkbox"/>	<input checked="" type="checkbox"/>	<input checked="" type="checkbox"/>	<input checked="" type="checkbox"/>
• TEXT RECORD	<input checked="" type="checkbox"/>	<input checked="" type="checkbox"/>	<input checked="" type="checkbox"/>	<input checked="" type="checkbox"/>
SAR LEADER FILE				
• DESCRIPTOR RECORD	<input checked="" type="checkbox"/>	<input checked="" type="checkbox"/>	<input checked="" type="checkbox"/>	<input checked="" type="checkbox"/>
• DATA SET SUMMARY	<input checked="" type="checkbox"/>	<input checked="" type="checkbox"/>	<input checked="" type="checkbox"/>	<input checked="" type="checkbox"/>
• DATA QUALITY SUMMARY		<input checked="" type="checkbox"/>	<input checked="" type="checkbox"/>	<input checked="" type="checkbox"/>
• SIGNAL DATA HISTOGRAM		<input checked="" type="checkbox"/>	<input checked="" type="checkbox"/>	<input checked="" type="checkbox"/>
• PROCESSED DATA (16-bit) HISTOGRAM		<input checked="" type="checkbox"/>	<input checked="" type="checkbox"/>	<input checked="" type="checkbox"/>
• PROCESSING PARAMETERS		<input checked="" type="checkbox"/>		
• MAP PROJECTION DATA			<input checked="" type="checkbox"/>	<input checked="" type="checkbox"/>
• PLATFORM POSITION DATA	<input checked="" type="checkbox"/>	<input checked="" type="checkbox"/>		
• ATTITUDE DATA		<input checked="" type="checkbox"/>		
• RADIOMETRIC DATA		<input checked="" type="checkbox"/>	<input checked="" type="checkbox"/>	<input checked="" type="checkbox"/>
• RADIOMETRIC COMPENSATION DATA		<input checked="" type="checkbox"/>	<input checked="" type="checkbox"/>	<input checked="" type="checkbox"/>
SAR DATA FILE				
• DESCRIPTOR RECORD	<input checked="" type="checkbox"/>	<input checked="" type="checkbox"/>	<input checked="" type="checkbox"/>	<input checked="" type="checkbox"/>
• SIGNAL DATA	<input checked="" type="checkbox"/>			
• PROCESSED DATA		<input checked="" type="checkbox"/>	<input checked="" type="checkbox"/>	<input checked="" type="checkbox"/>
NULL VOLUME DIRECTORY FILE				
• NULL VOLUME DESCRIPTOR	<input checked="" type="checkbox"/>	<input checked="" type="checkbox"/>	<input checked="" type="checkbox"/>	<input checked="" type="checkbox"/>

Record used in this Product.

Table A2.0 Organization of CEOS files for RISAT Products

Detailed information about the contents and structure of the records present in RISAT CEOS files is provided in subsequent sections.

A2.0.1 Detailed Description of RISAT-1 CEOS Records

Following is the explanation for the RISAT CEOS Record Contents:

In the Format column:

There are two types of data representation used, i.e. binary number (B) and ASCII character string (A, I, F, D and E) with field width in bytes (w) and digits after the decimal point (d), where

Bw	=	binary data,
<i>B4</i>	:	<i>denotes 4 bytes integer values unless specified as float</i>
Aw	=	ASCII character data,
Iw	=	integer number in textual form,
Fw.d	=	floating point number in textual form,
Dw.d	=	double precision number in textual form,
Ew.dEe	=	exponential number in textual form, and
e	=	exponent.

Example: “E16.7” means the format of the content of this field is defined as exponential number in text format, width 16 bytes, with 7 digits after the decimal point.

In the Content Column

Number	=	a constant value
“*”	=	a calculated or assigned value
“\$”	=	a space between characters
blanks	=	this field may be populated post-launch
spares	=	reserved fields

Sections A2.1 to Section A2.20 provide detailed description of the various parameters present in the various CEOS records.

A2.1: Volume Descriptor Record Contents
(for RAW, Geo-Tagged, Geo-Referenced and Value Added Products)

Number	Mnemonic	Bytes	Format	Content	Description
1	rec_seq	1-4	B4	1	Record sequence number
2	rec_sub1	5	B1	192	First record sub-type code
3	rec_type	6	B1	192	Record type code
4	rec_sub2	7	B1	18	Second record sub-type code
5	rec_sub3	8	B1	18	Third record sub-type code
6	length	9-12	B4	360	Length of this record
7	ascii_flag	13-14	A2	A\$	ASCII flag
8	spare1	15-16	A2	\$\$	Unused
9	format_doc	17-28	A12	RISAT-1-CEOS	Format control documentation
10	format_ver	29-30	A2	*	Format doc version
11	format_rev	31-32	A2	*	Format doc revision
12	software_id	33-44	A12	*	Software identifier
13	phyvol_id	45-60	A16	DISK\$\$\$\$\$\$\$\$\$\$	Physical volume identifier
14	logvol_id	61-76	A16	Level-0 : RISAT1L0mmmmRAW\$ Level-1 :SLANT RISAT1L1mmmmST\$\$ Level-1 :GROUND RISAT1L1mmmmGD\$\$ Level-2: RISAT1L2mmmmTGRX TGR::Terrain Geo-Referenced Value Added: TBD where mmmm= FRS1/FRS2/CRS\$/MRS\$/HRSS\$ X = U - UTM P - Polyconic	Logical volume identifier
15	volset_id	77-92	A16	Blanks	Volume set identifier
16	phyvol_cnt	93-94	I2	0	Total physical volume count
17	first_phyvol	95-96	I2	0	Physical volume of first tape
18	last_phyvol	97-98	I2	0	Physical volume of last tape
19	curr_phyvol	99-100	I2	0	Physical volume of current tape
20	first_file	101-104	I4	0	First file number in physical volume
21	volset_log	105-108	I4	\$\$\$1	Logical volume within set
22	phyvol_log	109-112	I4	\$\$\$1	Logical volume within phyvol
23	logvol_date	113-120	A8	YYYYMMDD	Logvol creation date
24	logvol_time	121-128	A8	HHMMSSMS	Logvol creation time
25	logvol_country	129-140	A12	INDIA\$\$\$\$\$\$/NORWAY\$\$\$\$\$\$	Logvol generation country
26	logvol_agency	141-148	A8	ISRO-DOS	Logvol generation agency
27	logvol_facility	149-160	A12	NRSC\$\$\$\$\$\$ / KSAT\$\$\$\$\$\$	Logvol generation facility
28	n_filepoint	161-164	I4	\$\$\$2	Number of file pointer records
29	n_voldir	165-168	I4	\$\$\$4	Number of records in volume directory file
30	spare2	169-260	A92	Blanks	Unused
31	product_id	261-300	A40	WORK-ORDER ID	Product identifier
32	spare3	301-360	A60	Blanks	Local use segment

A2.2: SAR Leader File Pointer Record
(for RAW, Geo-Tagged, Geo-Referenced and Value Added Products)

Number	Mnemonic	Bytes	Format	Content	Description
1	rec_seq	1-4	B4	2	Record sequence number
2	rec_sub1	5	B1	219	First record sub-type code
3	rec_type	6	B1	192	Record type code
4	rec_sub2	7	B1	18	Second record sub-type code
5	rec_sub3	8	B1	18	Third record sub-type code
6	length	9-12	B4	360	Length of this record
7	ascii_flag	13-14	A2	A\$	ASCII flag
8	spare1	15-16	A2	\$\$	Unused
9	file_num	17-20	I4	\$\$\$1	Referenced file number
10	file_name	21-36	A16	Level-0 : RISAT1L0mmmmRAW\$ Level-1 :SLANT RISAT1L1mmmmST\$\$ Level-1 :GROUND RISAT1L1mmmmGD\$\$ Level-2: RISAT1L2mmmmTGRX Value Added: TBD where mmmm= FRS1/FRS2/CRS\$/MRS\$/HRS\$ X = U - UTM P – Polyconic	Referenced file name
11	file_class	37-64	A28	SARLEADER\$FILE\$\$\$\$\$\$\$\$\$\$\$\$	Referenced file class
12	file_code	65-68	A4	SARL	Referenced file class code
13	data_type	69-96	A28	MIXED\$BINARY\$AND\$ASCII\$\$\$\$\$\$	Referenced file data type
14	data_code	97-100	A4	MBAA	Referenced file data type code
15	nrec	101-108	I8	RAW=\$\$\$\$\$\$3 Level-1=\$\$\$\$\$\$10 Level-2=\$\$\$\$\$\$8 Value Added=\$\$\$\$\$\$8	Referenced file record count
16	first_len	109-116	I8	\$\$\$\$\$720	First record length, bytes
17	max_len	117-124	I8	*	Maximum record length, bytes
18	len_type	125-136	A12	VARIABLE\$LEN	Record length type
19	len_code	137-140	A4	VARE	Record length type code
20	first_phyvol	141-142	I2	0	First physical volume
21	last_phyvol	143-144	I2	0	Last physical volume
22	first_rec	145-152	I8	\$\$\$\$\$\$\$1	First physical volume record
23	last_rec	153-160	I8	*	Last physical volume record
24	spare2	161-260	A100	blanks	Unused
25	spare3	261-360	A100	Blanks	Unused

A2.3: Image Options File Pointer Record Contents
(for RAW, Geo-Tagged, Geo-Referenced and Value Added Products)

Number	Mnemonic	Bytes	Format	Content	Description
1	rec_seq	1-4	B4	3	Record sequence number
2	rec_sub1	5	B1	219	First record sub-type code
3	rec_type	6	B1	192	Record type code
4	rec_sub2	7	B1	18	Second record sub-type code
5	rec_sub3	8	B1	18	Third record sub-type code
6	length	9-12	B4	360	Length of this record, bytes
7	ascii_flag	13-14	A2	A\$	ASCII flag
8	spare1	15-16	A2	\$\$	Unused
9	file_num	17-20	I4	\$\$\$2	Referenced file number
10	file_name	21-36	A16	Level-0 : RISAT1L0mmmmRAW\$ Level-1 :SLANT RISAT1L1mmmmST\$\$ Level-1 :GROUND RISAT1L1mmmmGD\$\$ Level-2: RISAT1L2mmmmTGRX Value Added: TBD where mmmm= FRS1/FRS2/CRSS/MRS\$/HRS\$ X = U - UTM P - Polyconic	Referenced file name
11	file_class	37-64	A28	IMAGERY\$OPTIONS\$FILE\$\$\$\$\$\$\$	Referenced file class
12	file_code	65-68	A4	IMOP	Referenced file class code
13	data_type	69-96	A28	MIXED\$BINARY\$AND\$ASCII\$\$\$\$\$\$\$	Referenced file data type
14	data_code	97-100	A4	MBAA	Referenced file data type code
15	nrec	101-108	I8	*	Referenced file record count
16	first_len	109-116	I8	\$\$\$16252	First record length, bytes
17	max_len	117-124	I8	*	Maximum record length, bytes
18	len_type	125-136	A12	VARIABLE\$LEN (for RAW) FIXED\$LENGTH (for others)	Record length type
19	len_code	137-140	A4	VARE (for RAW) FIXD (for others)	Record length type code
20	first_phyvol	141-142	I2	0	First physical volume
21	last_phyvol	143-144	I2	0	Last physical volume
22	first_rec	145-152	I8	1	First phyvol record
23	last_rec	153-160	I8	*	Last phyvol record
24	spare2	161-260	A100	Blanks	Unused
25	spare3	261-360	A100	Blanks	Unused

A2. 4: Text Record Contents
(for RAW, Geo-Tagged, Geo-Referenced and Value Added Products)

Number	Mnemonic	Bytes	Format	Content	Description
1	rec_seq	1-4	B4	4	Record sequence number
2	rec_sub1	5	B1	18	First record sub-type code
3	rec_type	6	B1	63	Record type code
4	rec_sub2	7	B1	18	Second record sub-type code
5	rec_sub3	8	B1	18	Third record sub-type code
6	length	9-12	B4	360	Length of this record
7	ascii_flag	13-14	A2	A\$	ASCII flag
8	cont_flag	15-16	A2	\$\$	Continuation flag
9	product_type	17-56	A40	Level-0 : PRODUCT : \$RISAT-1-mmmm- RAW\$SIGNAL\$\$\$\$\$\$ Level-1 :SLANT PRODUCT : \$RISAT-1-mmmm- SLANT\$GEOTAGGED\$\$ Level-1 :GROUND PRODUCT : \$RISAT-1-mmmm- GROUND\$GEOTAGGED\$\$ Level-2: PRODUCT : \$RISAT-1-mmmm- TERN\$X\$GEOREFRENC Value Added: TBD where mmmm= FRS1/FRS2/CRS\$/MRS\$/HRS\$ X = U - UTM P - Polyconic	Product type specifier
10	product_create	57-116	A60	PROCESS:\$cccccccccc\$aiaaaaaa\$fffffffff\$Y YYMMDD\$\$\$\$\$\$ (where: ccccccccc --- creating country; aiaaaaa --- creating agency; ffffffff --- creating facility)	Product creation info
11	phyvol_id	117-156	A40	DISK	Physical volume identifier
12	scene_id	157-196	A40	ORBIT\$:nnnnnnn\$DYYYYMMDD- Thhmsstt\$\$\$\$ nnnnnnn--- orbit number DYY...ttt—frame centre acquisition date and time	Scene identifier
13	scene_loc	197-236	A40	blank (for RAW) FRAME\$CENTRE:\$pXnnn.nn\$\$qXnnn.nn\$\$\$\$ \$\$ (where: p --- N or S latitude; q --- E or W longitude; X --- + or -; nnn.nn --- degrees)	Scene location
14	copyright_info	237-256	A20	Copyright CSA (yyyy) where yyyy is the year of acquisition	Copyright
15	spare2	257-360	A104	blanks	Unused

A2. 5: SAR Leader File - File Descriptor Record Contents
(for RAW, Geo-Tagged, Geo-Referenced and Value Added Products)

Number	Mnemonic	Bytes	Format	Content	Description
1	rec_seq	1-4	B4	1	Record sequence number
2	rec_sub1	5	B1	63	First record sub-type code
3	rec_type	6	B1	192	Record type code
4	rec_sub2	7	B1	18	Second record sub-type code
5	rec_sub3	8	B1	18	Third record sub-type code
6	length	9-12	B4	720	Length of this record
7	ascii_flag	13-14	A2	A\$	ASCII flag
8	spare1	15-16	A2	\$\$	Unused
9	format_doc	17-28	A12	RISAT-1-CEOS	Format control document
10	format_rev	29-30	A2	*	Format document revision
11	design_rev	31-32	A2	\$\$	File design revision
12	software_id	33-44	A12	*<n>.<m> where <n>.<m> is the version number	Software identifier
13	file_num	45-48	I4	\$\$\$1	File number
14	file_name	49-64	A16	Level-0 : RISAT1L0mmmmRAW\$ Level-1 :SLANT RISAT1L1mmmmST\$\$ Level-1 :GROUND RISAT1L1mmmmGD\$\$ Level-2: RISAT1L2mmmmTGRX Value Added: TBD where mmmm= FRS1/FRS2/CRS\$/MRS\$/HRS\$ X = U - UTM P - Polyconic	File name
15	rec_seq	65-68	A4	FSEQ	Record sequence/location flag
16	seq_loc	69-76	I8	\$\$\$\$\$\$1	Sequence number location
17	seq_len	77-80	I4	\$\$\$4	Sequence number length
18	rec_code	81-84	A4	FTYP	Record code/location flag
19	code_loc	85-92	I8	\$\$\$\$\$\$5	Record code location
20	code_len	93-96	I4	\$\$\$4	Record code length
21	rec_len	97-100	A4	FLGT	Record length/location flag
22	rlen_loc	101-108	I8	\$\$\$\$\$\$9	Record length location
23	rlen_len	109-112	I4	\$\$\$4	Record length, bytes
24-27	spare2	113-116	4A1	Blanks	Reserved
28	spare3	117-180	A64	Blanks	Reserved segment
29	n_dataset	181-186	I6	\$\$\$\$\$1	Number of dataset summary records
30	l_dataset	187-192	I6	\$\$4096	Data set summary record length, bytes
31	n_map_proj	193-198	I6	\$\$\$\$\$1 (for Level-2 and Value Added) \$\$\$\$\$0 (for others)	Number of map proj records
32	l_map_proj	199-204	I6	\$\$1620 (for Level-2 and Value Added) \$\$\$\$\$0 (for others)	Map projection record length, bytes
33	n_plat_pos	205-210	I6	\$\$\$\$\$1 \$\$\$\$\$0 (for Level-2)	Number of platform position records
34	l_plat_pos	211-216	I6	\$\$8960 \$\$\$\$\$0 (for Level-2)	Platform position record length, bytes

Number	Mnemonic	Bytes	Format	Content	Description
35	n_att_data	217-222	I6	\$\$\$\$\$1 (for Level-1) \$\$\$\$\$0 (for others)	Number of attitude data records
36	l_att_data	223-228	I6	\$\$8960 (for Level-1) \$\$\$\$\$0 (for others)	Attitude data record length, bytes
37	n_radi_data	229-234	I6	\$\$\$\$\$0 (RAW) \$\$\$\$\$1 (for others)	Number of radiometric data records
38	l_radi_data	235-240	I6	\$\$\$\$\$0 (RAW) \$\$9860 (for others)	Radiometric data record length, bytes
39	n_radi_comp	241-246	I6	\$\$\$\$\$0 (RAW) \$\$\$\$\$1 (for others)	Number of radiometric compensation records
40	l_radi_comp	247-252	I6	\$\$\$\$\$0 (RAW) \$50436 (for others)	Radiometric compensation record length, bytes
41	n_qual_sum	253-258	I6	\$\$\$\$\$0 (RAW) \$\$\$\$\$1 (for others)	Number of data quality summary records
42	l_qual_sum	259-264	I6	\$\$\$\$\$0 (RAW) \$\$1620 (for others)	Data quality summary record length, bytes
43	n_data_hist	265-270	I6	\$\$\$\$\$0 (for RAW,) \$\$\$\$\$2 (for others)	Number of data histogram records
44	l_data_hist	271-276	I6	\$\$\$\$\$0 (RAW,) \$16920 (for others)	Data histogram record length, bytes
45	n_rang_spec	277-282	I6	\$\$\$\$\$0	Number of range spectra records
46	l_rang_spec	283-288	I6	\$\$\$\$\$0	Range spectra record length, bytes
47	n_dem_desc	289-294	I6	\$\$\$\$\$0	Number of DEM descriptor records
48	l_dem_desc	295-300	I6	\$\$\$\$\$0	DEM description record length, bytes
49	n_radar_par	301-306	I6	\$\$\$\$\$0	Number of RADAR parameter records
50	l_radar_par	307-312	I6	\$\$\$\$\$0	RADAR parameter record length, bytes
51	n_anno_data	313-318	I6	\$\$\$\$\$0	Number of annotation data records
52	l_anno_data	319-324	I6	\$\$\$\$\$0	Annotation data record length, bytes
53	n_det_proc	325-330	I6	\$\$\$\$\$1 (for Level-1) \$\$\$\$\$0 (for others)	Number of detailed processing parameter records
54	l_det_proc	331-336	I6	\$\$9358 (for Level-1) \$\$\$\$\$0 (for others)	Detailed processing parameter record length, bytes
55	n_cal	337-342	I6	\$\$\$\$\$0	Number of calibration records
56	l_cal	343-348	I6	\$\$\$\$\$0	Calibration record length, bytes
57	n_gcp	349-354	I6	\$\$\$\$\$0	Number of GCP records
58	l_gcp	355-360	I6	\$\$\$\$\$0	GCP record length, bytes
59-68	spare4	361-420	10I6	\$\$\$\$\$0	Unused
69	n_fac_data	421-426	I6	\$\$\$\$\$0	Number of facility data records
70	l_fac_data	427-432	I6	\$\$\$\$\$0	Facility data record length, bytes
71	spare5	433-720	A288	Blanks	Unused

A2. 6: Data Set Summary Record Contents
(for RAW, Geo-Tagged, Geo-Referenced and Value Added Products)

Number	Mnemonic	Bytes	Format	Content	Description
1	rec_seq	1-4	B4	2	Record sequence number
2	rec_sub1	5	B1	18	First record sub-type code
3	rec_type	6	B1	10	Record type code
4	rec_sub2	7	B1	18	Second record sub-type code
5	rec_sub3	8	B1	20	Third record sub-type code
6	Length	9-12	B4	4096	Length of this record
7	seq_num	13-16	I4	1	Sequence number
8	sar_chn	17-20	I4	1	SAR channel indicator
9	scene_id	21-36	A16	Level-0 : RISAT1L0mmmmRAW\$ Level-1 :SLANT RISAT1L1mmmmST\$\$ Level-1 :GROUND RISAT1L1mmmmGD\$\$ Level-2: RISAT1L2mmmmTGRX Value Added: TBD where mmmm= FRS1/FRS2/CRS\$/MRS\$/HRS\$ X = U - UTM P - Polyconic	Scene identifier
10	scene_des	37-68	A32	Scene Identifier from referencing scheme ijmn i-3digits j-3digits m-2digits n-2digits	Scene designator
11	inp_sctim	69-100	A32	YYYYMMDDHHMSSttt\$\$\$\$\$\$\$\$\$\$\$\$	Input scene centre time
12	asc-des	101-116	A16	ASCENDING or DESCENDING	Ascending/Descending flag
13	pro_lat	117-132	F16.7	blank (for RAW) * (for others)	Processed scene centre latitude (deg.)
14	pro_long	133-148	F16.7	blank (for RAW) * (for others)	Processed scene centre longitude (deg.)
15	pro_head	149-164	F16.7	blank (for RAW) * (for others)	Processed scene centre Heading (deg.)
16	ellip_des	165-180	A16	WGS-84\$\$\$\$\$\$\$\$	Ellipsoid designator
17	ellip_maj	181-196	F16.7	*	Ellipsoid semi-major axis, km
18	ellip_min	197-212	F16.7	*	Ellipsoid semi_minor axis, km
19	earth_mass	213-228	E16.7	*	Earth's mass (kg)
20	grav_const	229-244	E16.7	*	Gravitational constant (m ^{3/(kg.s2)})
21-23	ellip_j	245-292	3E16.7	*	Ellipsoid J2-4 parameters
24	spare2	293-308	A16	Blank	Unused
25	terrain_h	309-324	F16.7	*	Average terrain height, km
26	sc_lin	325-332	I8	blank (for RAW) * (1/2 max no. lines for others)	Scene centre line number
27	sc_pix	333-340	I8	blank (for RAW) * (1/2 max no. pixels for others)	Scene centre pixel number
28	scene_len	341-356	F16.7	blank (for RAW) * (for others)	Scene length, km
29	scene_wid	357-372	F16.7	blank (for RAW) * (for others)	Scene width, km
30	date_of_pass	373-388	A16	YYYYMMDD\$\$\$\$\$\$	Date of Pass
31	nchn	389-392	I4	1	Number of SAR channels

Number	Mnemonic	Bytes	Format	Content	Description
32	spare5	393-396	A4	Blank	Unused
33	mission_id	397-412	A16	RISAT-1\$\$\$\$\$\$\$\$	Mission identifier
34	sensor_id	413-444	A32	RISAT-1-C\$-mmmm- pp\$\$\$\$...\$\$ mmmm=FRS1/FRS2/CRS\$/MRS\$/H RS\$ pp=HH/HV/VH/VV/LH/LV/RH/RV L-Left Circular R-Right Circular	Sensor identifier
35	orbit_num	445-452	A8	*	Orbit number
36	plat_lat	453-460	F8.3	*	Platform geodetic latitude (deg.)
37	plat_long	461-468	F8.3	*	Platform geodetic longitude (deg.)
38	plat_head	469-476	F8.3	*	Platform heading (deg.)
39	clock_ang	477-484	F8.3	blank	Sensor clock angle
40	incident_ang	485-492	F8.3	*	Incidence angle (deg.)
41	radar_freq	493-500	F8.3	*	Radar Frequency (GHz)
42	wave_length	501-516	F16.7	0.05607	Radar wave length (m)
43	motion_comp	517-518	A2	00	Motion compensation indicator
44	pulse_code	519-534	A16	LINEAR\$FM\$CHIRP\$	Range pulse code specifier
45 - 49	ampl_coef	535-614	5E16.7	blank	Range chirp coefficients
50 - 54	phas_coef	615-694	5E16.7	blank	Range phase coefficients
55	chirp_ext_ind	695-702	I8	blank	Chirp extraction index
56	spare6	703-710	A8	Blank	Unused
57	fr	711-726	F16.7	*(blank for RAW)	Range sampling rate (Hz)
58	rng_gate	727-742	F16.7	*(blank for RAW)	Range gate start time (s)
59	rng_length	743-758	F16.7	*	Range pulse length (s)
60	baseband_f	759-762	A4	blank	Baseband conversion flag
61	rngcmp_f	763-766	A4	*	Range compressed flag
62	gn_polar	767-782	F16.7	Blank	Like polarized gain
63	gn_cross	783-798	F16.7	Blank	Cross polarized gain
64	chn_bits	799-806	I8	8	Number of bits per channel
65	quant_desc	807-818	A12	UNIFORM\$I,Q\$	Quantization descriptor
66	i_bias	819-834	F16.7	blank (for RAW) * (for others)	I channel DC bias
67	q_bias	835-850	F16.7	blank (for RAW)* (for others)	Q channel DC bias
68	iq_ratio	851-866	F16.7	blank (for RAW)* (for others)	I/Q channel ratio
69	spare7	867-882	F16.7	Blank	Unused
70	spare8	883-898	F16.7	Blank	Unused
71	ele_sight	899-914	F16.7	blank	Electronic boresight
72	mech_sight	915-930	F16.7	Blank	Mechanical boresight
73	echo_track	931-934	A4	OFF\$	Echo tracker on/off flag
74	fa	935-950	F16.7	blank (RAW) * (for others)	Nominal PRF, Hz
75	elev_beam	951-966	F16.7	*	Elevation beamwidth
76	azim_beam	967-982	F16.7	*	Azimuth beamwidth
77	sat_bintim	983-998	I16	blank	Satellite binary time
78	sat_clktim	999-1030	I32	blank	Satellite clock time
79	sat_clkinc	1031-1038	I8	blank	Satellite clock increment
80	spare9	1039-1046	A8	blank	Unused
81	fac_id	1047-1062	A16	NRSC\$\$\$\$...\$ / KSAT\$\$\$\$...\$	Processing facility identifier
82	sys_id	1063-1070	A8	AIPD-SAC	Processing system identifier
83	ver_id	1071-1078	A8	V***	Processing version identifier
84	fac_code	1079-1094	A16	NRSC\$\$\$\$...\$ / KSAT\$\$\$\$...\$	Facility process code

Number	Mnemonic	Bytes	Format	Content	Description
85	lev_code	1095-1110	A16	*	Product level code
86	prod_type	1111-1142	A32	RAW=UNPROCESSED\$SIGNAL\$DATA\$\$\$\$\$\$ \$\$ Level-1:SLANT mmmm\$SINGLE\$LOOK\$COMPLEX\$IMAGE\$ Level-1:GROUND mmmm\$GROUND\$GEOTAGGED\$IMAGE\$\$\$ Level-2: mmmm\$TERRAIN\$GEOREFRENC\$D\$IMAGE\$X Value Added :TBD where mmmm= FRS1/FRS2/CRS\$/MRS\$/HRS\$ X = U - UTM P - Polyconic	Product type specifier
87	algor_id	1143-1174	A32	blank (for RAW) RANGE\$DOPPLER\$\$\$\$\$\$\$\$\$\$\$\$\$\$\$\$ (for others)	Processing algorithm identifier
88	n_azilok	1175-1190	F16.7	RAW=blank *(others)	Number of azimuth looks
89	n_rnglok	1191-1206	F16.7	RAW=blank *(others)	Number of range looks
90	bnd_azilok	1207-1222	F16.7	blank (RAW) * (others)	Azimuth look bandwidth (Hz)
91	bnd_rnglok	1223-1238	F16.7	blank (RAW) * (others)	Range look bandwidth (Hz)
92	bnd_azi	1239-1254	F16.7	blank (RAW) * (others)	Total azimuth look bandwidth (Hz)
93	bnd_rng	1255-1270	F16.7	blank (RAW) * (others)	Total range look bandwidth (Hz)
94	azi_weight	1271-1302	A32	* HAMMING (weighting = *) (blank for RAW)	Azimuth weighting designator
95	rng_weight	1303-1334	A32	* HAMMING (weighting = *) (blank for RAW)	Range weighting designator
96	data_inpsrc	1335-1350	A16	DISK	Data input source
97	rng_res	1351-1366	F16.7	blank (RAW) * (others)	Nominal resolution in range (meter)
98	azi_res	1367-1382	F16.7	blank (RAW) * (others)	Nominal resolution in azimuth (meter)
99 - 100	radi_stretch	1383-1414	2F16.7	*	Constant radiometric parameter (Bias) Linear radiometric parameter (Gain)
101 - 103	alt_dopcen	1415-1462	3E16.7	*	Along track Doppler frequency constant term at early edge of image (HZ) Along track Doppler frequency linear term at early edge of the image (Hz/pixel) Along track Doppler frequency quadratic term at early edge of the image (Hz/pixel/pixel)
104	spare10	1463-1478	A16	blank	Unused

Number	Mnemonic	Bytes	Format	Content	Description
105 - 107	crt_dopcen	1479-1526	3E16.7	*	Cross track Doppler freq term at early edge of image (HZ) Cross track Doppler frequency linear term at early edge of the image (Hz/pixel) Cross track Doppler frequency quadratic term at early edge of the image (Hz/pixel/pixel)
108	time_dir_pix	1527-1534	A8	*	Pixel time direction indicator
109	time_dir_lin	1535-1542	A8	*	Line time direction indicator
110 - 112	alt_rate	1543-1590	3E16.7	*	Along track Doppler rate term (Hz/s)
113	spare12	1591-1606	A16	blank	Unused
114 - 116	crt_rate	1607-1654	3E16.7	*(blank for RAW)	Cross track Doppler rate term (Hz/s)
117	spare13	1655-1670	A16	blank	Unused
118	line_cont	1671-1678	A8	RANGES\$\$\$ (for Level-0,Level-1) OTHER\$\$\$ (for others)	Line content indicator
119	clutter_lock	1679-1682	A4	blank	Clutter lock applied flag
120	auto_focus	1683-1686	A4	blank	Auto-focus applied flag
121	line_spacing	1687-1702	F16.7	blank (RAW) * (others)	Line spacing (m)
122	pix_spacing	1703-1718	F16.7	blank (RAW) * (others)	Pixel spacing (m)
123	rngcmp_desg	1719-1734	A16	blank	Range compression designator
124	Scene_centre_roll	1735-1750	F16.7	*	Scene centre roll (degrees)
125	Scene_centre_pitch	1751-1766	F16.7	*	Scene centre pitch(degrees)
126	Scene_centre_yaw	1767-1782	F16.7	*	Scene centre yaw (degrees)
127	yaw_steering_flag	1783-1786	I4	0=NO 1=YES	Yaw Steering Flag
128	pitch_steering_flag	1787-1790	I4	0=NO 1=YES	Pitch Steering Flag
129	dem_corr_applied	1791-1794	A4	blank (RAW,Level-1 SLANT) (YES/NO) (Level-1 GROUND , Level-2)	Whether DEM correction Applied
130	dem_source	1795-1834	A40	blank (RAW,Level-1 SLANT) * (if dem_corr_applied=YES) blank (if dem_corr_applied=NO) CARTO-1 or GTOPO	DEM Source
131	spare14	1791-4096	A2306	blanks	Unused

A2. 7: Data Quality Summary Record Contents
(for Geo-Tagged, Geo-Referenced and Value Added Products)

Number	Mnemonic	Bytes	Format	Comment	Description
1	rec_seq	1-4	B4	3	Record sequence number
2	rec_sub1	5	B1	18	First record sub-type code
3	rec_type	6	B1	60	Record type code
4	rec_sub2	7	B1	18	Second record sub-type code
5	rec_sub3	8	B1	20	Third record sub-type code
6	length	9-12	B4	1620	Length of this record
7	rec_seq	13-16	I4	1	Record sequence number
8	sar_chn	17-20	A4	1	SAR channel indicator
9	cali_date	21-26	A6	blank	Calibration update date
10	nchn	27-30	I4	1	Number of channels
11	islr	31-46	F16.7	*	Nominal Integrated side lobe ratio, dB
12	pslr	47-62	F16.7	*	Nominal Peak side lobe ratio, dB
13	azi_ambig	63-78	F16.7	blank	Nominal Azimuth ambiguity
14	rng_ambig	79-94	F16.7	blank	Nominal Range ambiguity
15	snr	95-110	F16.7	blank	Nominal Signal to noise ratio
16	ber	111-126	F16.7	blank	Nominal Bit error rate
17	rng_res	127-142	F16.7	*	Nominal slant range resolution, meters
18	azi_res	143-158	F16.7	*	Nominal Azimuth resolution, meters
19	rad_res	159-174	F16.7	*	Nominal radiometric resolution, dB
20	dyn_rng	175-190	F16.7	blank	Instantaneous dynamic range
21	rad_unc_db	191-206	F16.7	blank	Nominal Radiometric uncertainty, dB
22	rad_unc_deg	207-222	F16.7	blank	Radiometric uncertainty, deg
23	db	223-238	F16.7	blank	Units of db
24	deg	239-254	F16.7	blank	Units of deg
25-52	-	255-734	-	-	Repeat fields 23 to 24, 15 times
53	alt_locerr	735-750	F16.7	blank	Nominal Along track location error, meters
54	crt_locerr	751-766	F16.7	blank	Nominal Cross track location error, meters
55	alt_scale	767-782	F16.7	blank	Nominal geometric distortion scale in line direction
56	crt_scale	783-798	F16.7	blank	Nominal geometric distortion scale in pixel direction
57	dis_skew	799-814	F16.7	blank	Nominal Distortion skew
58	ori_err	815-830	F16.7	blank	Nominal Scene orientation error
59	alt_m	831-846	F16.7	blank	Nominal Along track misregistration
60	crt_m	847-862	F16.7	blank	Nominal Cross track misregistration
61-75	-	863-1342	-	-	Repeat fields 59 to 60, 15 times
76	nesz	1343-1358	F16.7	*	Nominal noise equivalent sigma zero, dB
77	enl	1359-1374	F16.7	*	Nominal equivalent Effective Number of Looks
78	tb_update	1375-1382	A8	blank	Default parameters table update date
79	spare	1383-1620	A238	blank	Unused

A2.8: Data Histogram Record - Signal Data
(for Geo-Tagged, Geo-Referenced and Value Added Products)

Number	Mnemonic	Bytes	Format	Content	Description
1	rec_seq	1-4	B4	4	Record sequence number
2	rec_sub1	5	B1	18	First record sub-type code
3	rec_type	6	B1	70	Record type code
4	rec_sub2	7	B1	18	Second record sub-type code
5	rec_sub3	8	B1	20	Third record sub-type code
6	length	9-12	B4	16920	Length of this record
7	rec_seq	13-16	I4	1	Record sequence number
8	sar_chn	17-20	I4	1	SAR channel number
9	ntab	21-28	I8	1	Number of histogram table data sets in this record
10	ltab	29-36	I8	\$\$\$\$2296	Histogram table data set size (bytes)
11	hist_desc	37-68	A32	JOINT\$I\$Q\$	Histogram descriptor; first 4 bit for Referenced I and the second 4 bit for Referenced Q in each bin.
12	nrec	69-72	I4	1	Records per table
13	tab_seq	73-76	I4	1	Table sequence number
14	nbin	77-84	I8	256	Total number of histogram bins.
15	ns_lin	85-92	I8	*	Number of lines sampled
16	ns_pix	93-100	I8	*	Number of pixels sampled
17	ngrp_lin	101-108	I8	4	Group size in line
18	ngrp_pix	109-116	I8	4	Groups size across line
19	nsamp_lin	117-124	I8	1	Samples in line group
20	nsamp_pix	125-132	I8	1	Samples across line group
21	min_smp	133-148	E16.7	0	Minimum first bin
22	max_smp	149-164	E16.7	255	Maximum last bin
23	mean_smp	165-180	E16.7	*	Mean sample value
24	std_smp	181-196	E16.7	*	Sample standard deviation
25	smp_inc	197-212	E16.7	1	Sample value increment
26	min_hist	213-228	E16.7	*	Minimum histogram value
27	max_hist	229-244	E16.7	*	Maximum histogram value
28	mean_hist	245-260	E16.7	*	Histogram mean value
29	std_hist	261-276	E16.7	*	Histogram standard deviation
30	nhist	277-284	I8	256	Histogram table size
31-286	hist	285-2332	256I8	*	256 Histogram table values of 16 bins for I x 16 bins for Q
287	spare	2333-16920	A14588	blanks	Unused

A2.9: Data Histogram Record - Processed Data (16-bit)
(for Geo-Tagged, Geo-Referenced and Value Added Products)

Number	Mnemonic	Bytes	Format	Content	Description
1	rec_seq	1-4	B4	5	Record sequence number
2	rec_sub1	5	B1	18	First record sub-type code
3	rec_type	6	B1	70	Record type code
4	rec_sub2	7	B1	18	Second record sub-type code
5	rec_sub3	8	B1	20	Third record sub-type code
6	length	9-12	B4	16920	Length of this record
7	rec_seq	13-16	I4	1	Record sequence number
8	sar_chn	17-20	I4	1	SAR channel number
9	ntab	21-28	I8	1 or 2	Number of histogram table data sets in this records
10	ltab	29-36	I8	8440	Histogram table data set size
11	hist_desc	37-68	A32	DETECTED\$DATA\$\$\$\$\$\$\$\$\$\$\$\$\$\$\$\$ (GROUND) I\$COMPONENT\$\$\$\$\$\$\$\$\$\$\$\$\$\$\$\$ (for SLANT)	Histogram descriptor. There are two histogram tables for SLC, one for I, the other for Q.
12	nrec	69-72	I4	1	Records per table
13	tab_seq	73-76	I4	1	Table sequence number
14	nbin	77-84	I8	1024	Total number of table bins.
15	ns_lin	85-92	I8	*	Number of lines sampled
16	ns_pix	93-100	I8	*	Number of pixels sampled
17	ngrp_lin	101-108	I8	*	Group size in line
18	ngrp_pix	109-116	I8	*	Groups size across line
19	nsamp_lin	117-124	I8	*	Samples in line group
20	nsamp_pix	125-132	I8	*	Samples across line group
21	min_smp	133-148	E16.7	0 (GROUND/GEO-REFERENCED) -32768 (SLC)	Minimum first bin
22	max_smp	149-164	E16.7	65535 (GROUND/GEO-REFERENCED) +32767 (SLC)	Maximum last bin
23	mean_smp	165-180	E16.7	*	Mean sample value
24	std_smp	181-196	E16.7	*	Sample standard deviation
25	smp_inc	197-212	E16.7	64	Sample value increment
26	min_hist	213-228	E16.7	*	Minimum histogram value
27	max_hist	229-244	E16.7	*	Maximum histogram value
28	mean_hist	245-260	E16.7	*	Histogram mean value
29	std_hist	261-276	E16.7	*	Histogram standard deviation
30	nhist	277-284	I8	1024	Histogram table size
31-1054	hist	285-8476	1024I8	*	Histogram table values for 1024 bins
1055	hist_desc	8477-8508	A32	SLANT= Q\$COMPONENT\$\$\$\$\$\$\$\$\$\$\$\$\$\$\$\$	Histogram descriptor. For GROUND products fields 1055 to 2098 are blank.
1056	nrec	8509-8512	I4	SLC=1	Records per table
1057	tab_seq	8513-8516	I4	SLC=2	Table sequence number
1058	nbin	8517-8524	I8	SLC=1024	Total number of table bins

Number	Mnemonic	Bytes	Format	Content	Description
1059	ns_lin	8525-8532	I8	SLC=*	Number of lines sampled
1060	ns_pix	8533-8540	I8	SLC=*	Number of pixels sampled
1061	ngrp_lin	8541-8548	I8	SLC=*	Group size in line
1062	ngrp_pix	8549-8556	I8	SLC=*	Groups size across line
1063	nsamp_lin	8557-8564	I8	SLC=*	Samples in line group
1064	nsamp_pix	8565-8572	I8	SLC=*	Samples across line group
1065	min_smp	8573-8588	E16.7	SLC=-32768	Minimum first bin
1066	max_smp	8589-8604	E16.7	SLC=+32767	Maximum last bin
1067	mean_smp	8605-8620	E16.7	SLC=*	Mean sample value
1068	std_smp	8621-8636	E16.7	SLC=*	Sample standard deviation
1069	smp_inc	8637-8652	E16.7	SLC=64	Sample value increment
1070	min_hist	8653-8668	E16.7	SLC=*	Minimum histogram value
1071	max_hist	8669-8684	E16.7	SLC=*	Maximum histogram value
1072	mean_hist	8685-8700	E16.7	SLC=*	Histogram mean value
1073	std_hist	8701-8716	E16.7	SLC=*	Histogram standard deviation
1074	nhist	8717-8724	I8	SLC=1024	Histogram table size
1075-2098	hist	8725-16916	1024I8	SLC=*	Histogram table
2099	spare	16917-16920	A3	blanks	Unused

A2.10: Detailed Processing Parameters Record Contents (for Geo-Tagged products)

Number	Mnemonic	Bytes	Format	Content	Description
1	rec_seq	1-4	B4	6	Record sequence number
2	rec_sub1	5	B1	18	First record sub-type code
3	rec_type	6	B1	120	Record type code
4	rec_sub2	7	B1	18	Second record sub-type code
5	rec_sub3	8	B1	20	Third record sub-type code
6	length	9-12	B4	9358	Length of this record
7	rec-seq	13-16	I4	1	Record sequence number
8	spare1	17-20	A4	blank	Unused
9	inp_media	21-23	A3	DSK	Input media; DSK=Disk
10	n_tape_id	24-27	I4	blank	Number of input tape identifiers
11	tape_id	28-107	10A8	blank	Tape identifiers
12	exp_ing_start	108-128	A21	YYYY-DDD-HH:MM:SS.SSS	Expected ingest start time; satellite time code
13	exp_ing_stop	129-149	A21	YYYY-DDD-HH:MM:SS.SSS	Expected ingest stop time; satellite time code
14	act_ing_start	150-170	A21	YYYY-DDD-HH:MM:SS.SSS	Actual ingest start time; satellite time code
15	act_ing_stop	171-191	A21	YYYY-DDD-HH:MM:SS.SSS	Actual ingest stop time; satellite time code
16	proc_start	192-212	A21	YYYY-DDD-HH:MM:SS.SSS	Processing start time; satellite time code
17	proc_stop	213-233	A21	YYYY-DDD-HH:MM:SS.SSS	Processing stop time; satellite time code
18-27	mn_sig_lev	234-393	10F16.7	blank	Mean signal levels across range
28	src_data_ind	394-397	I4	blank	Source data quality indicator
29	miss_ln	398-405	I8	blank	Number of missing lines
30	rej_ln	406-413	I8	blank	Number of rejected lines
31	large_gap	414-421	I8	blank	Number of time inconsistencies (large gaps)
32	bit_err_rate	422-437	E16.7	blank	Measured bit error rate
33	fm_crc_err	438-453	E16.7	blank	Percent of frames with CRC errors
34	date_incons	454-461	I8	blank	Number of date inconsistencies
35	prf_changes	462-469	I8	*	Number of unexpected PRF changes
36	delay_changes	470-477	I8	*	Number of delay changes
37	skipd_frames	478-485	I8	blank	Number of skipped frames
38	rej_bf_start	486-493	I8	blank	Range lines rejected before start time
39	rej_few_fram	494-501	I8	blank	Range lines rejected due to too few frames
40	rej_many_fram	502-509	I8	blank	Range lines rejected due to too many frames
41	rej_mchn_err	510-517	I8	blank	Frames rejected due to master channel error
42	rej_vchn_err	518-525	I8	blank	Frames rejected due to virtual channel error
43	rej_rec_type	526-533	I8	blank	Frames rejected due to incorrect recording type
44	sens_config	534-543	A10	ASCENDING/DESCENDING	Sensor configuration (ascending/descending)
45	sens_orient	544-552	A9	*	Sensor orientation (right/left looking)
46	sychn_marker	553-560	A8	blank	Frame synch marker
47	rng_ref_src	561-572	A12	REPLICA\$DATA	Range reference function source
48-51	rng_amp_coef	573-636	4E16.7	blank	Range reference amplitude coefficients
52-55	rng_phas_coef	637-700	4E16.7	blank	Range reference phase coefficients
56-59	err_amp_coef	701-764	4E16.7	blank	Error function amplitude coefficients
60-63	err_phas_coef	765-828	4E16.7	blank	Error function phase coefficients
64	pulse_bandw	829-832	I4	*	Pulse bandwidth x 10 ⁻² MHz
65	adc_samp_rate	833-837	A5	*	ADC sampling rate (x 10 ⁻³ Msamp/s)
66	rep_agc_attn	838-853	F16.7	blank	Replica AGC attenuation
67	gn_corcfn_fctr	854-869	F16.7	blank	Gain correction factor (dB)

Number	Mnemonic	Bytes	Format	Content	Description
68	rep_energy_g n	870-885	F16.7	blank	Replica energy gain correction
69	orb_data_src	886-896	A11	*	Orbit data source; specifies whether the orbit file or Signal Data Ephemeris was used
70	pulse_cnt_1	897-900	I4	blank	Pulse count 1
71	pulse_cnt_2	901-904	I4	blank	Pulse count 2
72	beam_edge_r qd	905-907	A3	NO\$	Beam edge detection requested
73	beam_edge_c onf	908-923	F16.7	blank	Beam edge confidence measure
74	pix_overlap	924-927	I4	*	Number of pixels in beam overlap (only for multiple beam modes)
75	n_beams	928-931	I4	*	Number of beams
76	beam_type	932-934	A3	*	Beam type
77	beam_look_sr c	935-943	A9	NOMINAL	Elevation beam look angle source
78	beam_look_an g	944-959	F16.7	*	Applied elevation beam look angle (deg)
79	prf	960-975	F16.7	*	Actual PRF (Hz)
80-91	-	976-1459	-	-	Repeat fields 76 to 79 another 11 times
92	n_pix_updates	1460-1463	I4	blank	Number of pixel count updates
93	pix_update	1464-1484	A21	blank	Pixel count update date/time
94-97	n_pix	1485-1580	12I8	*	Count of image pixels in beams
98-192	-	1581-3803	-	-	Repeat fields 93 to 97 another 19 times
193	pwin_start	3804-3819	F16.7	*	Processing window start time (sec)
194	pwin_end	3820-3835	F16.7	*	Processing window end time (sec)
195	recd_type	3836-3844	A9	REAL\$TIME/PLAYBACK	Recording type
196	temp_set_inc	3845-3860	F16.7	blank	Time increment between temperature settings (sec)
197	n_temp_set	3861-3864	I4	blank	Number of temperature settings
198-201	temp_set	3865-3880	4I4	blank	Temperature settings
202-277	-	3881-4184	-	-	Repeat fields 198 to 201 another 19 times
278	n_image_pix	4185-4192	I8	*	Number of image pixels sampled
279	prc_zero_pix	4193-4208	F16.7	blank	Per cent zero pixels
280	prc_satur_pix	4209-4224	F16.7	blank	Per cent saturated pixels
281	img_hist_mea n	4225-4240	F16.7	*	Image histogram mean intensity
282-284	img_cumu_dis t	4241-4288	3F16.7	blank	Image cumulative distribution
285	pre_img_gn	4289-4304	F16.7	blank	Pre-image calibration gain factor
286	post_img_gn	4305-4320	F16.7	blank	Post-image calibration gain factor
287	dopcen_inc	4321-4336	F16.7	*	Time increment between Dopcen estimates (sec)
288	n_dopcen	4337-4340	I4	*	Number of Doppler centroid estimates
289	dopcen_conf	4341-4356	F16.7	blank	Doppler centroid confidence measure
290	dopcen_ref_ti m	4357-4372	F16.7	blank	Doppler centroid reference time (sec)
291-294	dopcen_coef	4373-4436	4F16.7	*	Doppler centroid coefficients (Hz)
295-408	-	4437-6260	-	-	Repeat fields 289 to 294 maximum 19 times
409	dopamb_err	6261-6264	I4	blank	Doppler ambiguity error
410	dopamb_conf	6265-6280	F16.7	blank	Doppler ambiguity confidence measure
411-417	eph_orb_data	6281-6392	7E16.7	blank	Ephemeris orbit data
418	appl_type	6393-6404	A12	blank	Application type
419-423	slow_time_co ef	6405-6514	5D22.15	blank	Slow time coefficients
424	n_srgr	6515-6518	I4	*	Number of SRGR coefficient sets

Number	Mnemonic	Bytes	Format	Content	Description
425	sgrg_update	6519-6539	A21	blank	SRGR update date/time
426-431	sgrg_coef	6540-6635	6E16.7	*[s0,s1,s2,s3,s4,s5]	SRGR coefficients For j^{th} pixel; Range= $s_0 + s_1.j + s_2.j^2 + s_3.j^3 + \dots$
432-564	-	6636-8858	-	-	Repeat fields 425 to 431 maximum 19 times
565	pixel_spacing	8859-8874	F16.7	*	product pixel spacing
566	gics_reqd	8875-8877	A3	YES/NO\$	GICS product required. When this field is set to "NO" then fields 567-584 will be blank
567	wo_number	8878-8885	A8	blanks	Work order identifier
568	wo_date	8886-8905	A20	DD-MMM-YYYY\$HH:MM:SS	Work order entry date
569	satellite_id	8906-8915	A10	RISAT-1\$\$\$	Satellite identifier
570	user_id	8916-8935	A20	blank	User id
571	complete_msg	8936-8938	A3	blank	Completion message required flag
572	scene_id	8939-8953	A15	blank	product scene identifier
573	density_in	8954-8957	A4	blank	Density of product media
574	media_id	8958-8965	A8	blank	product identifier
575	angle_first	8966-8981	F16.7	blank	Incidence angle of first pixel in a line
576	angle_last	8982-8997	F16.7	blank	Incidence angle of last pixel in a line
577	prod_type	8998-9000	A3	blank	GeoReferenced output product type
578	map_system	9001-9016	A16	Blank	Map system identifier
579	centre_lat	9017-9038	D22.15	Blank	GeoReferenced output product scene centre latitude
580	centre_long	9039-9060	D22.15	Blank	GeoReferenced output product scene centre longitude
581	span_x	9061-9082	D22.15	Blank	GeoReferenced output product size - map eastings (km)
582	span_y	9083-9104	D22.15	Blank	GeoReferenced output product size - map northings (km)
583	apply_dtm	9105-9107	A3	Blank	DTM correction to be applied flag
584	density_out	9108-9111	A4	Blank	GeoReferenced output product density
585	state_time	9112-9132	A21	YYYY-DDD-HH:MM:SS.ccc	Time of the first state vector
586	num_state_vectors	9133-9136	I4	*	Number of state vectors
587	state_time_inc	9137-9152	F16.7	*	Time increment between state vectors (sec)
588	Coord_sys	9153-9164	A12	ZERO_DOPPLER	Scene output coordinate system
589	Spare2	9165-9358	A194	blank	Unused

A2.11: Map Projection Data Record Contents (Geo-Referenced and Value Added Products)

Number	Mnemonic	Bytes	Format	Content	Description
1	rec_seq	1-4	B4	6	Record sequence number
2	rec_sub1	5	B1	18	First record sub-type code
3	rec_type	6	B1	20	Record type code
4	rec_sub2	7	B1	18	Second record sub-type code
5	rec_sub3	8	B1	20	Third record sub-type code
6	length	9-12	B4	1620	Length of this record
7	spare1	13-28	A16	blanks	Unused
8	map_desc	29-60	A32	*	Map projection descriptor
9	n_pixel	61-76	I16	*	Number of pixels per line
10	n_line	77-92	I16	*	Number of lines per processed band
11	pixel_spacing	93-108	F16.7	*	Nominal inter-pixel distance, meters
12	line_spacing	109-124	F16.7	*	Nominal inter-line distance, meters
13	osc_orient	125-140	F16.7	*	Output scene centre orientation, degrees
14	orb_incl	141-156	F16.7	*	Actual platform orbital inclination, degrees
15	asc_node	157-172	F16.7	blank	Actual ascending node, degrees
16	isc_dist	173-188	F16.7	*	Distance of platform at input scene centre from the geocentre, metres
17	geo_alt	189-204	F16.7	*	Geodetic platform altitude, metres
18	isc_vel	205-220	F16.7	*	Actual ground speed at nadir at input scene centre time, metres/sec
19	plat_head	221-236	F16.7	*	Platform heading, degrees
20	ref_ellip	237-268	A32	*	Reference ellipsoid name
21	semi_major	269-284	F16.7	*	Ellipsoid semi-major axis, metres
22	semi_minor	285-300	F16.7	*	Ellipsoid semi-minor axis, metres
23 24 25	datum_shift	301-348	3F16.7	blank	Datum shift parameter referenced to Greenwich: dx (metres) Datum shift parameter perpendicular to Greenwich: dy (metres) Datum shift parameter direction of the rotation axis: dz (metres)
26 27 28	aux_datum_shift	349-396	3F16.7	blank	Additional datum shift parameter 1st rotation angle Additional datum shift parameter 2nd rotation angle Additional datum shift parameter 3rd rotation angle
29	scal_ellip	397-412	F16.7	blank	Reference ellipsoid scale factor
30	proj_desc	413-444	A32	*	Map projection alphanumeric description
31	utm_desc	445-476	A32	UNIVERSAL\$TRANSVERSE\$MERIDIAN\$PROJECTOR\$\$\$	UTM descriptor
32	utm_zone_sig	477-480	A4	*	UTM zone signature
33	utm_east_orig	481-496	F16.7	*	Map origin, false easting
34	utm_north_orig	497-512	F16.7	*	Map origin, false northing
35	utm_cent_long	513-528	F16.7	*	Projection centre longitude, deg
36	utm_cent_lat	529-544	F16.7	*	Projection centre latitude, deg
37-38	utm_stand_par	545-576	2F16.7	blank	1st and 2nd standard parallels, deg
39	utm_scale	577-592	F16.7	*	Scale factor
40	ups_desc	593-624	A32	blank	UPS descriptor
41	ups_cent_long	625-640	F16.7	blank	Projection centre longitude, deg
42	ups_cent_lat	641-656	F16.7	blank	Projection centre latitude, deg
43	ups_scale	657-672	F16.7	blank	Scale factor
44	nsp_desc	673-704	A32	*	NSP descriptor (44-59 blank if in UTM)

Number	Mnemonic	Bytes	Format	Content	Description
45	nsp_east_orig	705-720	F16.7	*	Map origin, false easting
46	nsp_north_orig	721-736	F16.7	*	Map origin, false northing
47	nsp_cent_long	737-752	F16.7	*	Projection centre longitude, deg
48	nsp_cent_lat	753-768	F16.7	*	Projection centre latitude, deg
49	nsp_stand_par1	769-784	F16.7	*	Standard parallels, deg
50	nsp_stand_par2	785-800	F16.7	*	Standard parallels, deg
51	nsp_stand_par3	801-816	F16.7	*	Standard parallels, deg
52	nsp_stand_par4	817-832	F16.7	*	Standard parallels, deg
53	nsp_stand_mer1	833-848	F16.7	*	Central meridian, deg
54	nsp_stand_mer2	849-864	F16.7	*	Central meridian, deg
55	nsp_stand_mer3	865-880	F16.7	*	Central meridian, deg
56	nsp_spare1	881-896	A16	*	Projection dependent
57	nsp_spare2	897-912	A16	*	Projection dependent
58	nsp_spare3	913-928	A16	blanks	Unused
59	nsp_spare4	929-944	A16	blanks	Unused
60	corner_ne	945-1072	8F16.7	*	Top left corner northing, meters;
61					Top left corner easting, meters;
62					Top right corner northing, meters;
63					Top right corner easting, meters;
64					Bottom right corner northing, meters;
65					Bottom right corner easting, meters;
66					Bottom left corner northing, meters;
67					Bottom left corner easting, meters;
68	corner_ll	1073-1200	8F16.7	*	Top left corner latitude, deg;
69					Top left corner longitude, deg;
70					Top right corner latitude, deg;
71					Top right corner longitude, deg;
72					Bottom right corner latitude, deg;
73					Bottom right corner longitude, deg;
74					Bottom left corner latitude, deg;
75					Bottom left corner longitude, deg;
76	terr_height	1201-1264	4F16.7	*	Top left corner terrain height relative to
77					ellipsoid, meters;
78					Top right corner terrain height, meters;
79					Bottom right corner height, meters;
80-87	lp_conv_coef	1265-1424	8E20.10	*	8 coefficients to convert a line and pixel position to the map projection frame of reference
88-95	mp_conv_coef	1425-1584	8E20.10	*	8 coefficients to convert from the map projection to line and pixel position in the image
96	dem_type	1585-1588	A4	*	DEM type
97	spare3	1589-1620	A32	blanks	Unused

A2.11.1: Polyconic Projection (default projection is UTM)

Field	Mnemonic	Bytes	Format	Contents	Description
44	nsp_desc	673-704	A32	POLYCONIC\$\$\$\$\$ \$\$\$\$\$\$\$\$\$\$\$\$\$\$\$\$	NSP descriptor
45	nsp_east_orig	705-720	F16.7	*	Map Origin (false easting) (m)
46	nsp_north_orig	721-736	F16.7	*	Map Origin (false northing) (m)
47	nsp_cent_long	737-752	F16.7	*	Center of projection longitude (deg)
48	nsp_cent_long	753-768	F16.7	*	Center of projection latitude (deg)
49	nsp_stand_par1	769-784	F16.7	*	Standard parallels (deg)
50	nsp_stand_par2	785-800	F16.7	*	Standard parallels (deg)
51	nsp_stand_par3	801-816	F16.7	*	Standard parallels (deg)
52	nsp_stand_par4	817-832	F16.7	*	Standard parallels (deg)
53	nsp_stand_mer1	833-848	F16.7	*	Central meridian (deg)
54	nsp_stand_mer2	849-864	F16.7	*	Central meridian (deg)
55	nsp_stand_mer3	865-880	F16.7	*	Central meridian (deg)
56	nsp_spare1	881-896	A16	blanks	spares
57	nsp_spare2	897-912	A16	blanks	spares
58	nsp_spare3	913-928	A16	blanks	spares
59	nsp_spare4	929-944	A16	blanks	Spares

A2.12: Platform Position Data Record Contents
(for RAW and Geo-Tagged Products)

Number	Mnemonic	Bytes	Format	Content	Description
1	rec_seq	1-4	B4	3 (RAW) 7 (Level-1)	Record sequence number
2	rec_sub1	5	B1	18	First record sub-type code
3	rec_type	6	B1	30	Record type code
4	rec_sub2	7	B1	18	Second record sub-type code
5	rec_sub3	8	B1	20	Third record sub-type code
6	length	9-12	B4	8960	Length of this record, bytes
7	orbit_ele_desg	13-44	A32	blank	Orbital elements designator
8 9 10 11 12 13	orbit_ele	45-140	6F16.7	a = semi major axis (km) i = inclination (radians) e = eccentricity (unitless) ω = argument of pericenter (radians) l = longitude of the node (radians) M = Mean anomaly (radians)	Orbital elements
14	ndata	141-144	I4	*	Number of data points
15	year	145-148	I4	*	Year of first data point
16	month	149-152	I4	*	Month of first data point
17	day	153-156	I4	*	Day of first data point
18	gmt_day	157-160	I4	*	Day of year of first data point
19	gmt_sec	161-182	D22.15	*	Seconds of day of first data point
20	data_int	183-204	D22.15	*	Data sampling interval (sec)
21	ref_coord	205-268	A64	INERTIAL\$...\$	Reference coordinate system
22	hr_angle	269-290	D22.15	*	Greenwich mean hour angle (deg)
23	alt_poserr	291-306	F16.7	blank	Along track position error
24	crt_poserr	307-322	F16.7	blank	Cross track position error
25	rad_poserr	323-338	F16.7	blank	Radial position error
26	alt_velerr	339-354	F16.7	blank	Along track velocity error
27	crt_velerr	355-370	F16.7	blank	Cross track velocity error
28	rad_velerr	371-386	F16.7	blank	Radial velocity error
29	pos	387-452	3D22.15	*	Data point position (m)
30	vel	453-518	3D22.15	*	Data point velocity (m/s)
31 -156	-	519-8834	-	-	Repeat fields 29 to 30, (ndata-1) times
157	sidereal_angle	8835-8842	F8.3	*	Sidereal angle (deg.) value corresponding to first state vector (fields 29,30)
158-171	-	8843-8954	-	-	Repeat field 157 (ndata-1) times for subsequent state vectors (fields 31-156)
172	spare	8955-8960	A6	blanks	Unused

**A2.13: Attitude Data Record
(for Geo-Tagged Products)**

Number	Mnemonic	Bytes	Format	Content	Description
1	rec_seq	1-4	B4	8	Record sequence number
2	rec_sub1	5	B1	18	First record sub-type code
3	rec_type	6	B1	40	Record type code
4	rec_sub2	7	B1	18	Second record sub-type code
5	rec_sub3	8	B1	20	Third record sub-type code
6	length	9-12	B4	8960	Length of this record, bytes
7	npoint	13-16	I4	*	Number of data points
8	gmt_day	17-20	I4	*	Day of the year, GMT
9	gmt_msec	21-28	I8	*	Milliseconds of day, GMT
10	pitch_flag	29-32	I4	blank	Pitch data quality flag
11	roll_flag	33-36	I4	Blank	Roll data quality flag
12	yaw_flag	37-40	I4	Blank	Yaw data quality flag
13	pitch	41-54	E14.6	blank	Pitch error, degrees
14	roll	55-68	E14.6	blank	Roll error, degrees
15	yaw	69-82	E14.6	Blank	Yaw error, degrees
16	pitch_rate_flag	83-86	I4	blank	Pitch rate data quality flag
17	roll_rate_flag	87-90	I4	Blank	Roll rate data quality flag
18	yaw_rate_flag	91-94	I4	Blank	Yaw rate data quality flag
19	pitch_rate	95-108	E14.6	*	Pitch rate, degrees/sec
20	roll_rate	109-122	E14.6	*	Roll rate, degrees/sec
21	yaw_rate	123-136	E14.6	*	Yaw rate, degrees/sec
22	-	137-2416	-	-	Repeat fields 8 to 21, 19 times
23	pitch_bias	2417-2430	E14.6	*	Pitch bias, degrees.
24	roll_bias	2431-2444	E14.6	*	Roll bias, degrees.
25	yaw_bias	2445-2458	E14.6	*	Yaw bias, degrees.
26	spare	2459-8960	A6502	blank	Unused

A2.14: Radiometric Data Record Contents
(for Geo-Tagged, Geo-Referenced and Value Added Products)

Number	Mnemonic	Bytes	Format	Content	Description
1	rec_seq	1-4	B4	9 (Level-1) 7 (Level-2/VA)	Record sequence number
2	rec_sub1	5	B1	18	First record sub-type code
3	rec_type	6	B1	50	Record type code
4	rec_sub2	7	B1	18	Second record sub-type code
5	rec_sub3	8	B1	20	Third record sub-type code
6	length	9-12	B4	9860	Length of this record
7	seq_num	13-16	I4	1	Record sequence number
8	n_data	17-20	I4	1	Number of data sets
9	field_size	21-28	I8	9840	Data set size in bytes
10	chan_ind	29-32	A4	1	SAR channel indicator
11	spare1	33-36	A4	blank	Unused
12	table_desig	37-60	A24	OUTPUT\$SCALING\$\$\$\$\$\$\$\$	Table designator
13	n_samp	61-68	I8	*	Number of lookup table samples
14	samp_type	69-84	A16	GAIN\$\$\$\$\$\$\$\$	Sample type designator
15	samp_inc	85-88	I4	*	Increment between table entries, range samples
16 - 527	lookup_tab	89-8280	512E16.7	*	Output scaling gain table
528	spare2	8281-8284	A4	blank	Unused
529	noise_scale	8285-8300	F16.7	blank	Thermal noise reference level (db)
530	spare3	8301-8316	F16.7	blank	Unused
531	offset	8317-8332	E16.7	blank	Scaling offset
532	calib_const	8333-8348	E16.7	*	Calibration constant (dB)
533	calib_const_Gamma0	8349-8364	E16.7	*	Calibration constant Gamma0 (dB)
534	calib_const_Beta0	8365-8380	E16.7	*	Calibration constant Beta0 (dB)
535	spare4	8381-9860	A1512	blank	Unused

A2.15: Radiometric Compensation Data Record
(for Geo-Tagged, Geo-Referenced and Value Added Products)

Number	Mnemonic	Bytes	Format	Content	Description
1	rec_seq	1-4	B4	10 (Level-1) 8 (Level-2)	Record sequence number
2	rec_sub1	5	B1	18	First record sub-type code
3	rec_type	6	B1	51	Record type code
4	rec_sub2	7	B1	18	Second record sub-type code
5	rec_sub3	8	B1	20	Third record sub-type code
6	length	9-12	B4	50436	Length of this record
7	seq_num	13-16	I4	1	Record sequence number
8	chan_ind	17-20	I4	1	SAR channel indicator
9	n_dset	21-28	I8	*	Number of data sets in record
10	dset_size	29-36	I8	4200	Compensation data set size
11	comp_desig	37-44	A8	RANGE\$\$\$	Compensation data designator
12	comp_descr	45-76	A32	ELEVATION\$ANTENNA\$PATTERNS\$RN\$\$\$\$\$\$	Compensation data descriptor
13	n_comp_rec	77-80	I4	1	Number of compensation records
14	comp_seq_no	81-84	I4	1	Record sequence number
15	beam_tab_size	85-92	I8	*	Number of beam table entries
16	beam_tab	93-4188	256F16.7	*	Elevation gain beam profile
17	beam_type	4189-4204	A16	*	Beam type
18	look_angle	4205-4220	F16.7	*	Look angle of beam table centre (deg.)
19	beam_tab_inc	4221-4236	F16.7	*	Increment between beam table entries
20	-	4237-50436	-	repeat according to no. of beams (maximum of 12 beams)	Repeat fields 11 to 19

A2.16: Image Options File Descriptor Record
(for RAW, Geo-Tagged, Geo-Referenced and Value Added Products)

Number	Mnemonic	Bytes	Format	Content	Description
1	rec_seq	1-4	B4	1	Record sequence number
2	rec_sub1	5	B1	63	First record sub-type code
3	rec_type	6	B1	192	Record type code
4	rec_sub2	7	B1	18	Second record sub-type code
5	rec_sub3	8	B1	18	Third record sub-type code
6	length	9-12	B4	16252	Length of this record
7	ascii_flag	13-14	A2	A\$	ASCII flag
8	spare1	15-16	A2	\$\$	Unused
9	format_doc	17-28	A12	RISAT-1-CEOS	Format control document
10	format_rev	29-30	A2	\$\$	Format document revision
11	design_rev	31-32	A2	\$\$	File design revision
12	software_id	33-44	A12	*	Software identifier
13	file_num	45-48	I4	\$\$\$2	File number
14	file_name	49-64	A16	Level-0 : RISAT1L0mmmmRAW\$ Level-1 :SLANT RISAT1L1mmmmST\$\$ Level-1 :GROUND RISAT1L1mmmmGD\$\$ Level-2: RISAT1L2mmmmTGRX Value Added: TBD where mmmm= FRS1/FRS2/CRS\$/MRS\$/HRSS\$ X = U - UTM P - Polyconic	File name
15	rec_seq	65-68	A4	FSEQ	Record sequence/location flag
16	seq_loc	69-76	I8	\$\$\$\$\$\$1	Sequence number location
17	seq_len	77-80	I4	\$\$\$4	Sequence number length
18	rec_code	81-84	A4	FTYP	Record code/location flag
19	code_loc	85-92	I8	\$\$\$\$\$\$5	Record code location
20	code_len	93-96	I4	\$\$\$4	Record code length
21	rec_len	97-100	A4	FLGT	Record length/location flag
22	rln_loc	101-108	I8	\$\$\$\$\$\$9	Record length location
23	rln_len	109-112	I4	\$\$\$4	Record length, bytes
24-27	spare2	113-116	4A1	blank	Reserved
28	spare3	117-180	A64	blank	Reserved segment
29	n_dataset	181-186	I6	*	Number of SAR data records
30	l_dataset	187-192	I6	*	SAR data record length, bytes
31	spare4	193-216	A24	blanks	Unused
32	nbit	217-220	I4	\$\$\$8 (RAW) \$\$\$16 (SLC,GROUND,Level-2)	Number of bits per sample
33	nsamp	221-224	I4	\$\$\$2 (RAW, SLC) \$\$\$1 (others)	Samples per data group
34	nbyte	225-228	I4	\$\$\$2 (RAW, GROUND,Level-2) \$\$\$4 (SLC)	Bytes per data group or per pixel
35	justify	229-232	A4	*(BIGE)-Big Endian	Sample justification and order
36	nchn	233-236	I4	\$\$\$1	Number of SAR channels
37	nlin	237-244	I8	*	Lines per data set

Number	Mnemonic	Bytes	Format	Content	Description
38	nleft	245-248	I4	\$\$\$0	Left border pixels per line
39	ngrp	249-256	I8	*(blank for RAW)	Groups per line per channel
40	nright	257-260	I4	\$\$\$0	Right border pixels per line
41	ntop	261-264	I4	\$\$\$0	Top border lines
42	nbott	265-268	I4	\$\$\$0	Bottom border lines
43	intleav	269-272	A4	BSQ\$	Interleave indicator
44	nrec_lin	273-274	I2	\$1	Records per line
45	nrec_chn	275-276	I2	\$1	Records per channel
46	n_prefix	277-280	I4	\$180	Prefix data per record
47	n_sar	281-288	I8	*	SAR data byte count
48	n_suffix	289-292	I4	0	Suffix data per record
49	spare5	293-296	A4	\$\$\$\$	Unused
50	lin_loc	297-304	A8	blank	Line number locator
51	chn_loc	305-312	A8	blank	Channel number locator
52	tim_loc	313-320	A8	blank	Time locator
53	left_loc	321-328	A8	blank	Left fill locator
54	right_loc	329-336	A8	blank	Right fill locator
55	pad_ind	337-340	A4	blank	Pad pixel indicator
56	spare6	341-368	A28	blanks	Unused
57	qual_loc	369-376	A8	blank	Quality code locator
58	cali_loc	377-384	A8	blank	Calibration info locator
59	gain_loc	385-392	A8	blank	Gain value locator
60	bias_loc	393-400	A8	blank	Bias value locator
61	type_id	401-428	A28	RAW=COMPLEX\$INTEGER*2\$\$\$\$\$\$\$\$\$ GROUND/Level-2 = UNGNED\$INTEGER*2\$\$\$\$\$\$\$\$\$ SLC=COMPLEX\$INTEGER*4\$\$\$\$\$\$\$\$\$	Data type identifier
62	type_code	429-432	A4	RAW=CI*2 GROUND/Level-2 =IU2\$ SLC=Ci*4	Data type code
63	left_fill	433-436	I4	*	Number left fill bits
64	right_fill	437-440	I4	*	Number right fill bits
65	pix_rng	441-448	I8	RAW=127 GROUND/Level-2=\$\$\$65535 SLC=\$\$\$32767	Pixel data range
66	replica_present	449-460	A12	ACTUAL/STORED	Replica Present ACTUAL: Valid Replica in Data STORED: If no valid Replica ,stored replica will be given
67	replica_rec_index	461-466	I6	*(applicable for RAW only) -99999(others)	Replica Record Index : Will be the last record in Signal data record contents
68	spare7	467-16252	A15786	Blanks	Unused

A2.17: Signal Data Record Contents
(for RAW products)

Number	Mnemonic	Bytes	Format	Content	Description
1	rec_seq	1-4	B4	*	Record sequence number. There will be one or more signal data records
2	rec_sub1	5	B1	50	First record sub-type code
3	rec_type	6	B1	10	Record type code
4	rec_sub2	7	B1	18	Second record sub-type code
5	rec_sub3	8	B1	20	Third record sub-type code
6	length	9-12	B4	*	Length of this record
7	line_num	13-16	B4	*	Signal data line number
8	rec_num	17-20	B4	1	Signal data record index
9	n_left_pixel	21-24	B4	0	Left fill pixel count
10	n_data_pixel	25-28	B4	*	Data pixel count
11	n_right_pixel	29-32	B4	0	Right fill pixel count.
12	sensor_updf	33-36	B4	1	Sensor parameter update flag
13	acq_year	37-40	B4	*	Acquisition year
14	acq_day	41-44	B4	*	Acquisition day of year
15	acq_msec	45-48	B4 (float)	*	Acquisition msecs of day
16	sar_chan_ind	49-50	B2	1	SAR channel indicator
17	sar_chan_code	51-52	B2	2	SAR channel code
18	tran_polar	53-54	B2	*(1=V;2=H;3=Left Circular,4=Right Circular)	Transmitted polarization
19	recv_polar	55-56	B2	*(1=V;2=H)	Received polarization
20	prf	57-60	B4 (float)	*	Pulse repetition frequency, Hz
21	replica_flag	61-64	B4	0/1	will be 1 if this record is replica record else 0
22	obrc	65-66	B2	0	On-board range compressed flag
23	pulse_type	67-68	B2	0	Pulse type designator
24	chp_len	69-72	B4	*	Chirp length, ns when this record is replica rec
25	chp_coef1	73-76	B4	0	Chirp constant coefficients (Hz)
26	chp_coef2	77-80	B4	0	Chirp linear coefficients (Hz/usec)
27	chp_coef3	81-84	B4	0	Chirp quadratic coefficients (Hz/usec**2)
28	msec_add_fact	85-88	B4	*	factor to be added to field 15 (acq_msec) to get actual value of milliseconds at acquisition
29	spare2	89-92	B4	0	Spare
30	recv_gain	93-96	B4	0	Receiver gain
31	nt_line	97-100	B4	0	Nought line flag
32	ele_nadir	101-104	B4	Blank	Elec. nadir angle, 10**-6 deg
33	mec_nadir	105-108	B4	Blank	Mech. nadir angle, 10**-6 deg
34	ele_squint	109-112	B4	Blank	Elec. squint angle, 10**-6 deg
35	mec_squint	113-116	B4	Blank	Mech. squint angle, 10**-6 deg
36	sr_first	117-120	B4 (float)	*	First sample slant range, m

Number	Mnemonic	Bytes	Format	Content	Description
37	dr_window	121-124	B4	*	Data record window time, ns
38	spare3	125-128	B4	0	Spare
39	plat_updf	129-132	B4	0	Platform position update flag
40	plat_lat	133-136	B4	*	Platform latitude, 10**-6 deg
41	plat_long	137-140	B4	*	Platform longitude, 10**-6 deg
42	plat_alt	141-144	B4 (float)	*	Platform altitude, m
43	plat_speed	145-148	B4 (float)	*	Platform speed, cm/s
44	plat_vel	149-160	3B4 (float)	*	Platform velocity, cm/s
45	plat_acc	161-172	3B4 (float)	*	Platform acceleration, cm/s2
46	plat_track	173-176	B4	0	Platform track, 10**-6 deg
47	plat_head	177-180	B4	*	Platform heading, 10**-6 deg
48	plat_pitch	181-184	B4	*	Platform pitch, 10**-6 deg
49	plat_roll	185-188	B4	*	Platform roll, 10**-6 deg
50	plat_yaw	189-192	B4	*	Platform yaw, 10**-6 deg
51	sdr_data	193-i	jB1	* where: i = number of bytes (i = 192 + j) j = number of bytes in range line	AUX Data (192 Bytes) + SAR Signal data (1byte I ; 1byte Q) + 2 Bytes Trailer AUX Data and Trailer Format in: 2.20 (AUX Data Format) In case of Replica Record: (replica_flag=1) this field will only be Replica Data (1byte I ; 1byte Q)

**B4 : denotes 4 bytes integer values unless specified as float*

A2.18: Processed Data Record
(for Geo-Tagged, Geo-Referenced and Value Added Products)

Number	Mnemonic	Bytes	Format	Content	Description
1	rec_seq	1-4	B4	*	Record sequence number. There may be one or more than one processed data record
2	rec_sub1	5	B1	50	First record sub-type code
3	rec_type	6	B1	11	Record type code
4	rec_sub2	7	B1	18	Second record sub-type code
5	rec_sub3	8	B1	20	Third record sub-type code
6	length	9-12	B4	*	Length of this record
7	line_num	13-16	B4	*	Image data line number. There may be one or more than one processed data record
8	rec_num	17-20	B4	1	Image data record index
9	n_left_pixel	21-24	B4	0	Left fill pixel count
10	n_data_pixel	25-28	B4	*	Data pixel count
11	n_right_pixel	29-32	B4	0	Right fill pixel count
12	sensor_updf	33-36	B4	0(Level-2) 1 (Others)	Sensor parameter update flag
13	acq_year	37-40	B4	* 0(Level-2)	Acquisition year, Time of Zero Doppler image line
14	acq_day	41-44	B4	* 0(Level-2)	Acquisition day of year, Time of Zero Doppler image line
15	acq_msec	45-48	B4 (float)	* 0(Level-2)	Acquisition msec of day, Time of Zero Doppler image line
16	sar_chan_ind	49-50	B2	1	SAR channel indicator
17	sar_chan_code	51-52	B2	*	SAR channel code
18	tran_polar	53-54	B2	*(1=V;2=H;3=Left Circular;4=Right Circular)	Transmitted polarization
19	recv_polar	55-56	B2	*(1=V;2=H)	Received polarization
20	prf	57-60	B4 (float)	*	Pulse repetition frequency, Hz
21	msec_add_fact	61-64	B4	*	factor to be added to field 15 (acq_msec) to get actual value of milliseconds at acquisition
22	sr_first	65-68	B4 (float)	* 0(Level-2)	Slant range to first pixel, m
23	sr_mid	69-72	B4 (float)	* 0(Level-2)	Slant range to mid-pixel, m
24	sr_last	73-76	B4 (float)	* 0(Level-2)	Slant range to last pixel, m
25	fdc_first	77-80	B4 (float)	*	First pixel Doppler centroid, Hz (single value is used to process full scene) (Hz)
26	fdc_mid	81-84	B4 (float)	*	Mid-pixel Doppler centroid, Hz (single value is used to process full scene) (Hz)
27	fdc_last	85-88	B4 (float)	*	Last pixel Doppler centroid, Hz (single value is used to process full scene) (Hz)
28	ka_first	89-92	B4 (float)	*	First pixel azimuth FM rate, Hz/s
29	ka_mid	93-96	B4 (float)	*	Mid-pixel azimuth FM rate, Hz/s
30	ka_last	97-100	B4 (float)	*	Last pixel azimuth FM rate, Hz/s
31	nadir_ang	101-104	B4	Blank	Nadir look angle, 10**-6 deg
32	squint_ang	105-108	B4	Blank	Azimuth squint angle, 10**-6 deg
33	null_f	109-112	B4	0	Null line flag
34-37	spare2	113-128	4B4	0	Unused

Number	Mnemonic	Bytes	Format	Content	Description
38	geo_updf	129-132	B4	1	Geographic ref. parameter update flag (1=data in this section is an update 0=data is a repeat)
39	lat_first	133-136	B4	*(blank for Level-2)	First pixel latitude (millionths of deg)
40	lat_mid	137-140	B4	*	Mid-pixel latitude (millionths of deg)
41	lat_last	141-144	B4	*(blank for Level-2)	Last pixel latitude (millionths of deg)
42	long_first	145-148	B4	*(blank for Level-2)	First pixel longitude (millionths of deg)
43	long_mid	149-152	B4	*	Mid pixel longitude (millionths of deg)
44	long_last	153-156	B4	*(blank for Level-2)	Last pixel longitude. (millionths of deg)
45	north_first	157-160	B4	*(Level-2 - for UTM Products only, else zero) 0 (others)	Northing of first pixel, m
46	spare3	161-164	B4	0	Unused
47	north_last	165-168	B4	*(Level-2 - for UTM Products only, else zero) 0 (others)	Northing of last pixel, m
48	east_first	169-172	B4	*(Level-2 - for UTM Products only, else zero) 0 (others)	Easting of first pixel, m
49	spare4	173-176	B4	0	Spare
50	east_last	177-180	B4	*(Level-2 - for UTM Products only, else zero) 0 (others)	Easting of last pixel, m
51	heading	181-184	B4	*(compute from 1st\last pixels)	Line heading, (millionths of deg)
52	spare5	185-192	B8	0	Spare
53	pdr_data	193-i	jBk	* where: i = number of bytes (i = 192 +j*k) j = number of pixels on this record k = 2 (for GROUND/Level-2) = 4 (for SLC) For SLC in B4 1-2 bytes I sample 3-4 bytes Q sample Data in Big Endian Format	SAR processed data

**B4 : denotes 4 bytes integer values unless specified as float*

A2. 19: Null Volume Descriptor Record Contents
(for RAW, Geo-Tagged, Geo-Referenced and Value Added Products)

Number	Mnemonic	Bytes	Format	Content	Description
1	rec_seq	1-4	B4	1	Record sequence number
2	rec_sub1	5	B1	192	First record sub-type code
3	rec_type	6	B1	192	Record type code
4	rec_sub2	7	B1	63	Second record sub-type code
5	rec_sub3	8	B1	18	Third record sub-type code
6	length	9-12	B4	360	Length of this record, bytes
7	ascii_flag	13-14	A2	A\$	ASCII flag
8	spare1	15-16	A2	\$\$	Unused
9	format_doc	17-28	A12	RISAT-1-CEOS	Format control doc
10	format_ver	29-30	A2	\$\$	Format doc version
11	format_rev	31-32	A2	\$\$	Format doc revision
12	software_id	33-44	A12	*	Software identifier
13	tape_id	45-60	A16	blanks	Physical tape id
14	logvol_id	61-76	A16	blank	Logical volume id
15	phyvol_id	77-92	A16	blank	Physical volume id
16	n_phyvol	93-94	I2	0	Number of physical volumes
17	first_phyvol	95-96	I2	0	First physical volume
18	last_phyvol	97-98	I2	0	Last physical volume
19	curr_phyvol	99-100	I2	0	Current physical volume
20	first_file	101-104	I4	blank	First file in volume
21	volset_log	105-108	I4	\$\$\$2	Logical volume within set
22	logvol_vol	109-112	I4	\$\$\$2	Logical volume within physical volume
23	spare2	113-360	A248	blanks	Unused

A 2. 20: AUX Data Format
(for RAW Products only)

Number	Mnemonic	Bytes	Format	Valid/Invalid Bits	Content	Description
DACS INSERTED AUX DATA						
1	FSW	1-4	B4	ALL Valid	F8DD4259 (HEX)	Frame Sync Word (Fixed Value)
2	I/Q-V/H ID	5-6	B2	0-7 for V/H ID 8-15 for I/Q ID	-	-
3	Sensor ID	7-8	B2	ALL Valid	-	-
4	Beam PRF Count	9-10	B2	ALL Valid	-	-
5	DACS PRF Frame Count	11-14	B4	ALL Valid	-	-
PLC INSERTED AUX DATA (updates at each PRF)						
6	PLC PRF Count	15-18	B4	ALL Valid	0 to (2 ³² -1)	-
7	SAR Mode	19-20	B2	0-3 (SAR Mode) 4-11 are Invalid 12-15 Beam-Hop/Init Indicator	-	Defines the mode of SAR Operation D15-D8: 80 Beam HOP Change D15-D8: C0 Beam Continue D15-D8: 00 Beam Init Change
8	BAQ Select/CAL	21-22	B2	0-5 CAL Bits 6-7-don't Care 8-10 (BAQ) 11-15 Invalid	-	-
9	Chirp Select	23-24	B2	0-2 are Valid 3-15 are Invalid	-	-
10	Beam Seq.	25-26	B2	0-3 are Valid 4-15 are Invalid	0000-000B (HEX) (F for replica)	Value ranges from 1 st beam to 12 th beam. Updates with each 'Beam HOP' Pulse. Ref Table-A2.20.1 Replica data Beam sequence is "15" (hex 'F') fixed
11	Ant. Beam No.	27-28	B2	0-6 are Valid 7-15 are Invalid	0000-003E (HEX) 7 th Bit for Look Area	Right Looking 0 th to 60 th Right Looking Beams, 61 st for Left Half Antenna Operation, 62 nd for Right Half Antenna Operation and 63rd for CAL. Left Looking 64th to 124th for Left Looking Beams, 125th for Left Half Antenna Operation, 126th for Right Half Antenna Operation and 127th for CAL Ref. Table A2.20.2 A2.20.3 & A2.20.4 and Fig-1 for Antenna Beam and Look Angle information.
12	Pol. Comb.	29-30	B2	0-3 are Valid 4-15 are Invalid	Unmasked polarization combination format	-
13	PRI	31-32	B2	0-11 are valid 12-15 are Invalid	0420-0573 (HEX) 1056 to 1395 (DECIMAL)	Clk/Min PRF to Clk/Max PRF. Min. and Max. PRF Values are 2800 and 3700 respectively. Multiplication factor for conversion is 256E-9sec Replica data 'PRI' is 0x 0516 (hex) fixed corresponding to PRF = 3000Hz

14	nPRI	33-34	B2	ALL Valid	0000 to FFFF (HEX) 0 to 20 (Nominal Value)	No. of Invalid pulses at beam cross over. FRS-1 mode where all the 12 beams carry same information, invalid pulses can be considered valid pulses. Invalid pulses are applicable for Multi-FRS mode when there is beam parameter update. During Replica data nPRI is fixed as '0x00'
15	Window Start	35-36	B2	0-11 are Valid 12-15 are Invalid	0000 to 0573 (HEX) 0 to 1395 (DECIMAL)	CAL Mode window start is zero and max value cannot cross PRI Value. Window Start timing in Micro Seconds = (Count)/3.90625MHz 3.90625MHz is PLC Clock Frequency
16	No. of Samples or Data window count	37-38	B2	ALL Valid	0500-A000 (HEX) 1280-40960 (DECIMAL)	Original No. of samples in the data corresponding to data window size and sampling frequency. For FRS-2 BAQ=0: No of Valid Samples=Count-8 (First 8-Saples are invalid) For FRS-2 BAQ≠ 0: Modes No Of valid Samples = Count-128 (First 128 samples are invalid) For all Other Modes = All the count samples are valid Multiplication factor for conversion is 256E-9sec No. Of Samples = $\text{int}[(\text{Count}(\text{decimal}) * 256\text{ns} * \text{Sampling Freq}) / 128] * 128$ For replica data samples are corresponding to 26.1us (count 0x66 hex) and 13.1us (count 0x33 hex) for Normal and circular mode respectively
17	MGC Control	39-40	B2	0-5 are Valid for H 6-7 are Invalid 8-13 are valid for V 14-15 are invalid	$2^6 = 64$	-
18	Beam Duration	41-44	B4	ALL Valid	$2^{32} = 4294967296$	Number of PRF Pulses between two Beam-Hops Stuck to '1' during replica data because Beam-Hop contains only 2PRF pulses
19	OBT TT	45-46	B2	All Valid	0 to $(2^{16}-1)$	-
20	TM Status of Digital Subsystems	47-54	B8	ALL Valid	0 to $(2^{64}-1)$	-
21	CAL-PRF Counter	55-56	B2	0 to 8 – Valid 9 to 15 - Invalid	1 to 289	-
22	S/C Reserved	57-128		-	-	Reserved for future use

Contd....

Level- 0 Inserted Header Data (64 Bytes)

Number	Mnemonic	Bytes	Format	Content	Description
23	Sync Status	1	A1	(0 – good 1- bad)	-
24	GRT	20	I4-5I2-I6	(YYYYMMDDHHMMSSmmmMMM)	-
25	Line Count	10	A10	-	-
26	Polarisation Combination	5	A5	("VV/HH/VV+VH/HH+HV)	-
27	Beam Sequence number	3	A3	-	-
28	Beam Number	3	A3	-	-
29	Number of BAQ Blocks	4	A4	-	-
30	Number of Actual BAQ Blocks	4	A4	-	-
31	Spare	14	A4	-	-

DACS INSERTED TRAILER DATA						
Number	Mnemonic	Bytes	Format	Valid/Invalid Bits	Content	Description
1	BLOCK Count & Misc	1-2	B2	0-2 BAQ Select 3-5 Chirp Select, 6 BIST 7-15 BAQ No of Block	2 ⁹ = 512	-

Table-A2.20.1 : Beam Sequence					
Hex Count	D3	D2	D1	D0	Beam Definition
0	0	0	0	0	Don't Care
1	0	0	0	1	Beam #1
2	0	0	1	0	Beam #2
3	0	0	1	1	Beam #3
4	0	1	0	0	Beam #4
5	0	1	0	1	Beam #5
6	0	1	1	0	Beam #6
7	0	1	1	1	Beam #7
8	1	0	0	0	Beam #8
9	1	0	0	1	Beam #9
A	1	0	1	0	Beam #10
B	1	0	1	1	Beam #11
C	1	1	0	0	Beam #12
D	1	1	0	1	Don't Care
E	1	1	1	0	Don't Care
F	1	1	1	1	Replica Data

Table-A2.20.2: Antenna Beam No. (7-Bits): 0th to 60th Beam. 61st for Left Half and 62nd for Right Half. 7th bit is valid for Right Look(0) and Left look(1)

Dec Code	Hex Code	D6	D5	D4	D3	D2	D1	D0	Definition
0	00	0	0	0	0	0	0	0	Right Looking, First Beam (~100Kms)
60	60	0	1	1	1	1	0	0	Right Looking, Last Beam (~700Kms)
61	3D	0	1	1	1	1	0	1	Right Looking, Left Half 6m x 1m Antenna operational
62	3E	0	1	1	1	1	1	0	Right Looking, Right Half 6m x 1m Antenna operational
63	3F	0	1	1	1	1	1	1	-0.11degrees beam pointing - All TRMs On. Normally used for CAL operation
64	40	1	0	0	0	0	0	0	Left Looking, 1 st Beam (~100Kms)
124	7C	1	1	1	1	1	0	0	Left Looking, 61 st Beam (~700Kms)
125	7D	1	1	1	1	1	0	1	Left Looking, Left Half 6m x 1m Antenna operational
126	7E	1	1	1	1	1	1	0	Left Looking, Right Half 6m x 1m Antenna operational
127	7F	1	1	1	1	1	1	1	+0.11degrees beam pointing - All TRMs On. Normally used for CAL operation

Table-A2.20.3: Antenna Beam No. Vs Pointing Angle/Ground Swath (w.r.t 36deg as zero Pointing)

Beam number (RHS)	Beam Number in Hex (RHS)	Mean Look Angle(deg)	Mean Beamwidth (Deg)	Beam number (LHS)	Beam Number in Hex (LHS)	Mean Look Angle(deg)	Mean Beamwidth (Deg)	Active TRMs
0	0	-24.96	2.83	64	40	24.88	2.83	156
1	1	-24.05	2.80	65	41	24.01	2.79	156
2	2	-23.17	2.80	66	42	23.12	2.78	156
3	3	-22.28	2.79	67	43	22.21	2.78	156
4	4	-21.37	2.56	68	44	21.32	2.55	168
5	5	-20.48	2.55	69	45	20.44	2.54	168
6	6	-19.57	2.54	70	46	19.53	2.53	168
7	7	-18.67	2.52	71	47	18.66	2.51	168
8	8	-17.83	2.49	72	48	17.82	2.49	168
9	9	-17.00	2.49	73	49	16.98	2.49	168
10	A	-16.13	2.48	74	4A	16.11	2.48	168
11	B	-15.29	2.33	75	4B	15.25	2.33	180
12	C	-14.47	2.31	76	4C	14.45	2.33	180
13	D	-13.65	2.32	77	4D	13.64	2.33	180
14	E	-12.85	2.31	78	4E	12.81	2.31	180
15	F	-12.04	2.30	79	4F	12.00	2.31	180
16	10	-11.26	2.16	80	50	11.22	2.17	192
17	11	-10.48	2.15	81	51	10.44	2.16	192
18	12	-9.71	2.15	82	52	9.66	2.15	192
19	13	-8.98	2.15	83	53	8.93	2.15	192
20	14	-8.22	2.03	84	54	8.16	2.04	204
21	15	-7.50	2.03	85	55	7.44	2.03	204
22	16	-6.76	2.02	86	56	6.70	2.02	204
23	17	-6.05	2.03	87	57	5.99	2.03	204
24	18	-5.33	1.92	88	58	5.31	1.91	216
25	19	-4.65	1.91	89	59	4.62	1.90	216
26	1A	-3.96	1.91	90	5A	3.92	1.90	216
27	1B	-3.31	1.80	91	5B	3.27	1.80	228
28	1C	-2.64	1.81	92	5C	2.63	1.80	228
29	1D	-2.00	1.80	93	5D	1.97	1.80	228

30	1E	-1.36	1.73	94	5E	1.34	1.71	240
31	1F	-0.74	1.72	95	5F	0.71	1.72	240
32	20	-0.13	1.72	96	60	0.12	1.72	240
33	21	0.49	1.65	97	61	-0.51	1.66	252
34	22	1.08	1.65	98	62	-1.10	1.65	252
35	23	1.66	1.66	99	63	-1.68	1.64	252
36	24	2.24	1.57	100	64	-2.26	1.57	264
37	25	2.80	1.57	101	65	-2.82	1.57	264
38	26	3.34	1.50	102	66	-3.37	1.50	276
39	27	3.88	1.51	103	67	-3.91	1.51	276
40	28	4.42	1.45	104	68	-4.44	1.45	288
41	29	4.94	1.45	105	69	-4.95	1.45	288
42	2A	5.44	1.46	106	6A	-5.47	1.46	288
43	2B	5.95	1.46	107	6B	-5.97	1.46	288
44	2C	6.44	1.45	108	6C	-6.47	1.45	288
45	2D	6.94	1.46	109	6D	-6.96	1.46	288
46	2E	7.41	1.46	110	6E	-7.44	1.46	288
47	2F	7.88	1.45	111	6F	-7.90	1.46	288
48	30	8.34	1.46	112	70	-8.35	1.46	288
49	31	8.79	1.47	113	71	-8.81	1.47	288
50	32	9.22	1.47	114	72	-9.24	1.47	288
51	33	9.65	1.46	115	73	-9.68	1.46	288
52	34	10.09	1.48	116	74	-10.11	1.48	288
53	35	10.50	1.47	117	75	-10.52	1.47	288
54	36	10.91	1.48	118	76	-10.93	1.48	288
55	37	11.32	1.47	119	77	-11.33	1.47	288
56	38	11.71	1.48	120	78	-11.73	1.48	288
57	39	12.09	1.48	121	79	-12.11	1.48	288
58	3A	12.48	1.49	122	7A	-12.49	1.49	288
59	3B	12.84	1.48	123	7B	-12.86	1.48	288
60	3C	13.20	1.48	124	7C	-13.22	1.48	288
61	3D	-0.12	2.99	125	7D	0.09	2.91	144
62	3E	-0.17	2.92	126	7E	0.14	2.98	144
63	3F	-0.12	1.44	127	7F	0.11	1.44	144

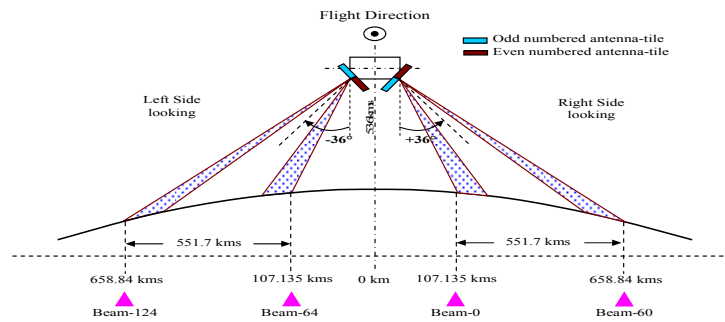

Fig.-1: Beam Command Definition

Table-A2.20.4: Antenna Beam No. Vs Pointing Angle

Beam number (RHS)	Beam Number in Hex (RHS)	Look Angle	Remarks	Active TRMs per Tiles	Beam number (LHS)	Beam Number in Hex (LHS)	Remarks
61	3D	-0.11	Odd tile is ON, Even tile is OFF	24	125	7D	Odd tile is OFF, Even tile is ON
62	3E	-0.11	Even tile is ON, Odd tile is OFF	24	126	7E	Odd tile is ON, Even tile is OFF
63	3F	-0.11	Both Odd & Even tiles are ON fully	24	127	7F	Both Odd & Even tiles are ON fully

Appendix-3

RISAT-1 GeoTIFF RECORD STRUCTURE AND CONTENTS

A3.0 GeoTIFF Format

All RISAT data products will be available in CEOS format. Depending upon the user requirement *level-2* i.e. *Geo-Referenced* products will also be available in GeoTIFF format. The basic product will contain a product information file and one or more image pixel data files as shown in Fig. A3.0. The *Product Information File* is an ASCII file that logically groups known information of the product. Groupings are provided for source, image generation and imagery information related to the product. The *Product Information File* will be encoded in *Extensible Markup Language (XML)* format. Corresponding to single, dual or quad polarization modes; one, two or four *Image Pixel Data Files* (in GeoTIFF format) may be included, respectively. Each file contains the raster SAR image for a given polarization. Support files (ex. readme files) are not mandatory and will be generated on demand.

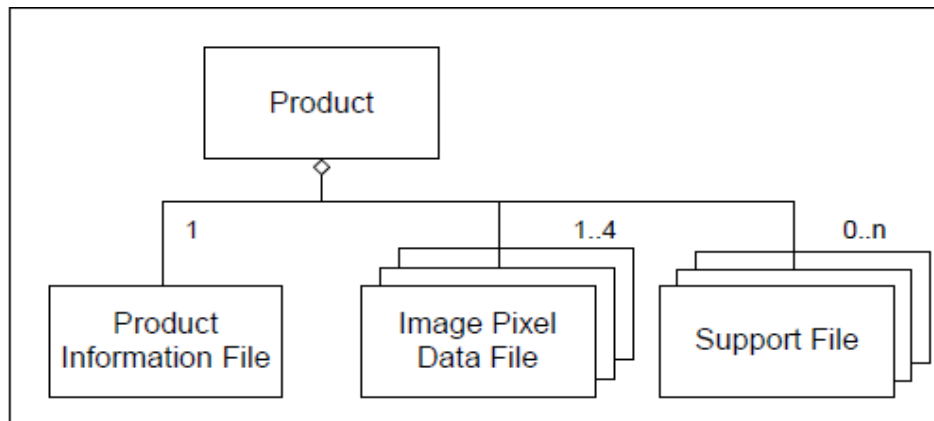

Fig A3.0 RISAT-1 GeoTIFF Product Composition

A3.1 Product Information File Format

The product is organized in hierarchical layers with the basic product layers being supplied by the RISAT-1 processor. Related information within the product is grouped into a Data Store. Figure-A3.1 shows how the Data Stores fit within the product hierarchy. Following are the contents of the Product Information File:

i) Product Parameters

Product parameters give information related to product and document identification, copyrights etc (Table A3.1.1).

	Product Parameters
•	productId
•	documentIdentifier
•	sourceAttributes
•	imageGenerationParameters
•	imageAttributes

Table A3.1.1 Product Parameters

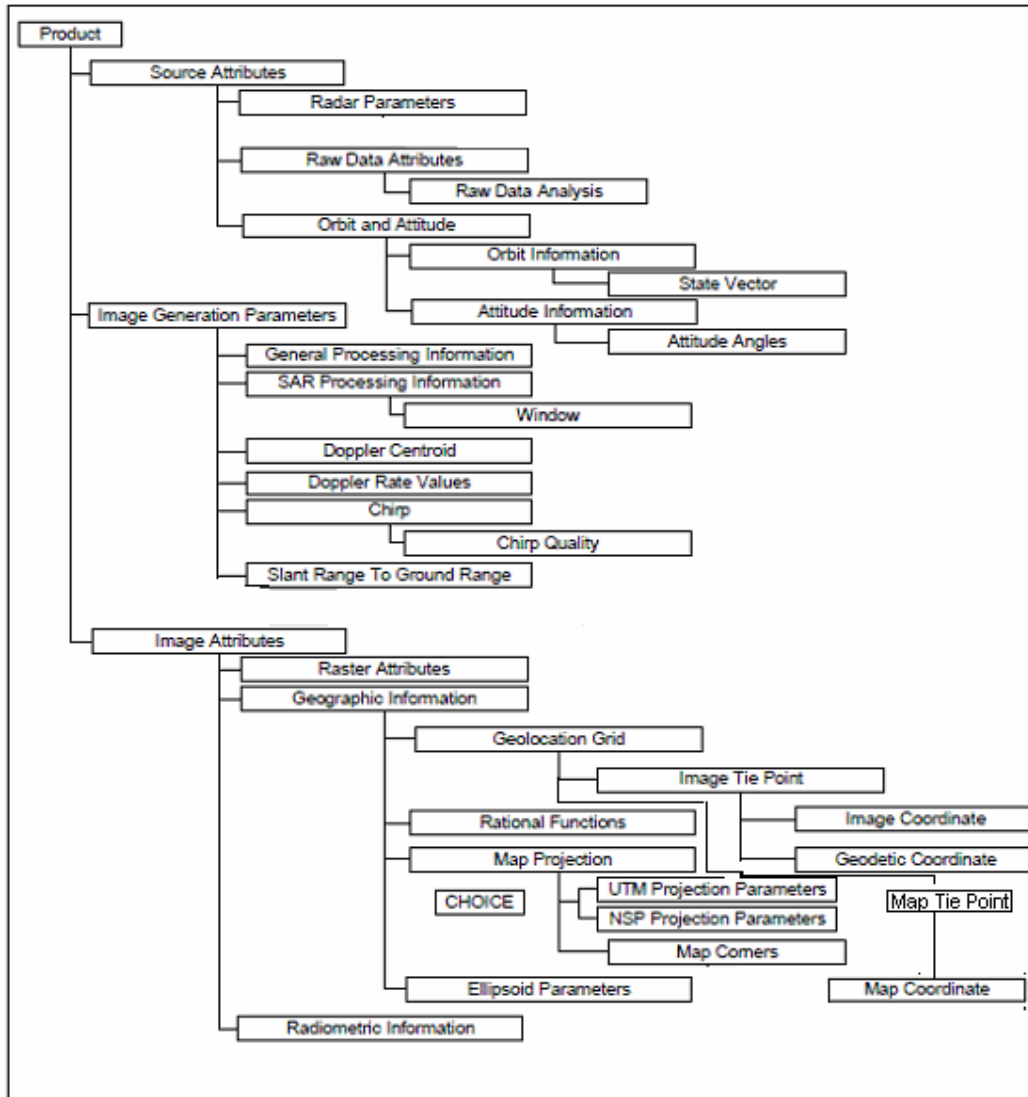

Fig A3.1 RISAT-1 Product Hierarchy

ii) Source Attributes

Source attributes provide information on the sensor characteristics, raw data and satellite orbit and attitude data (Table A3.1.2).

Source Attributes	
•	satellite
•	sensor
•	inputDatasetId
•	imageId
•	inputDatasetFacilityId
•	beamModeId
•	beamModeMnemonic
•	rawDataStartTime

Table A3.1.2 Source Attributes

Source Attributes/Radar Parameters			
Radar Parameters		Radar Parameters	
•	acquisitionType	•	beams
•	polarizations		
•	pulsesReceivedPerDwell beam	•	radarCenterFrequency units
•	pulseRepetitionFrequency beam	•	pulseLength
•	pulseBandwidth	•	antennaPointing
•	adcSamplingRate	•	yawSteeringFlag
•	geodeticFlag	•	rawBitsPerSample
•	samplesPerEchoLine beam		
Source Attributes/Raw Data Attributes/Raw Data Analysis			
Raw Data Analysis		Raw Data Analysis	
•	bias (I & Q)	•	standardDeviation (I & Q)
•	gainImbalance	•	phaseOrthogonality
•	rawDataHistogram (I & Q)		
Source Attributes/Orbit and Attitude			
Source Attributes/Orbit and Attitude/Orbit Information			
Orbit Information		Orbit Information	
•	passDirection	•	orbitDataSource
Source Attributes/Orbit and Attitude/Orbit Information/State Vector			
State Vector		State Vector	
•	timeStamp	•	xPosition
•	yPosition	•	zPosition
•	xVelocity	•	yVelocity
•	zVelocity		
Source Attributes/Orbit and Attitude/Attitude Information			
•	attitudeDataSource	•	attitudeOffsetsApplied
Source Attributes/Orbit and Attitude/Attitude Information/Attitude Angles			
Attitude Angles		Attitude Angles	
•	timeStamp	•	yaw
•	roll	•	pitch

Table A3.1.2 Source Attributes (contd...)

iii) Image Generation Parameters

Image generation parameters describe the processing applied to the source data to produce the output product. These include general and SAR processing information, Doppler Centroid, Doppler rates, chirp, chirp quality, and conversion from slant range to ground range (Table A3.1.3).

Image Generation Parameters/General Processing Information			
General Processing Information		General Processing Information	
•	productType	•	processingFacility
•	processingTime	•	softwareVersion
Image Generation Parameters/SAR Processing Information			
SAR Processing Information		SAR Processing Information	
•	lutApplied	•	elevationPatternCorrection

•	rawDataCorrection	•	rangeReferenceFunctionSource
•	dopplerSource	•	dopplerAmbiguityComputed
•	dopplerAmbiguityUsed	•	estimatedRollAngleUsed
•	radiometricSmoothingPerformed	•	zeroDopplerTimeFirstLine
•	zeroDopplerTimeLastLine	•	numberOfLinesProcessed per pole
•	samplingWindowStartTimeFirstRawLine	•	numberOfSwstChanges
•	numberOfRangeLooks	•	rangeLookBandwidth
•	totalProcessedRangeBandwidth	•	numberOfAzimuthLooks
•	azimuthLookBandwidth	•	totalProcessedAzimuthBandwidth
•	incidenceAngleNearRange	•	incidenceAngleFarRange
•	slantRangeNearEdge	•	satelliteHeight
Image Generation Parameters/SAR Processing Information/Window			
	Window		Window
•	windowName	•	windowCoefficient
Image Generation Parameters/Doppler Centroid			
	Doppler Centroid		Doppler Centroid
•	timeOfDopplerCentroidEstimate	•	dopplerAmbiguity
•	dopplerCentroidPolynomialPeriod	•	dopplerCentroidCoefficients
Image Generation Parameters/Doppler Rate Values			
	Doppler Rate Values		Doppler Rate Values
•	dopplerRateReferenceTime	•	dopplerRateValuesCoefficients
Image Generation Parameters/Chirp/Chirp Quality			
	Chirp Quality		Chirp Quality
•	crossCorrelationWidth	•	sideLobeLevel
•	integratedSideLobeRatio	•	crossCorrelationPeakLoc
Image Generation Parameters/Slant Range to Ground Range			
	Slant Range to Ground Range		Slant Range to Ground Range
•	zeroDopplerAzimuthTime	•	slantRangeTimeToFirstRangeSample

Table 3.1.3 Image Generation Parameters

iv) Image Attributes

Image attributes describe image-related information such as raster attributes (line/pixel information), geographical location, map projection, radiometric information and image pixel data file location (Table 3.1.4).

Image Attributes			
	Image Attributes		Image Attributes
•	productFormat	•	outputMediaInterleaving
Image Attributes/Raster Attributes			
	Raster Attributes		Raster Attributes
•	dataType	•	bitsPerSample
•	numberOfSamplesPerLine	•	numberOfLines
•	sampledPixelSpacing	•	sampledLineSpacing
•	lineTimeOrdering	•	pixelTimeOrdering

Image Attributes/Geographic Information			
Geographic Information		Geographic Information	
•	geolocationGrid	•	imageTiePoint
•	imageCoordinate	•	geodeticCoordinate
•	MapTiePonts	•	Map Coordinates
Image Attributes/Geographic Information/Reference Ellipsoid Parameters			
Reference Ellipsoid Parameters		Reference Ellipsoid Parameters	
•	ellipsoidName	•	semiMajorAxis
•	semiMinorAxis	•	datumShiftParameters
•	geodeticTerrainHeight		
Image Attributes/Geographic Information/Map Projection			
Map Projection		Map Projection	
•	mapProjectionDescriptor	•	resamplingKernel
•	DEMCorrection	•	DEMSource
•	satelliteHeading		

Image Attributes/Geographic Information/Map Projection/UTMProjectionParam's			
UTM Projection Parameters		UTM Projection Parameters	
•	utmZone	•	hemisphere
•	mapOriginFalseEasting	•	mapOriginFalseNorthing
Image Attributes/Geographic Information/Map Projection/NSPProjectionParam's			
NSP Projection Parameters		NSP Projection Parameters	
•	mapOriginFalseEasting	•	mapOriginFalseNorthing
•	centerofProjectionLongitude	•	centerofProjectionLatitude
•	standardParallels1	•	standardParallels2
•	zone		
Image Attributes/Geographic Information/Map Projection/Map Corners			
Map Corners		Map Corners	
•	upperLeftCorner	•	upperRightCorner
•	lowerRightCorner	•	lowerLeftCorner
Image Attributes/Radiometric Information			
•	Mean	•	standardDeviation
Image Attributes			
•	calibrationConstant pole	•	calibrationConstant_Gamma0 pole
•	calibrationConstant_Beta0 pole	•	fullResolutionImageData

Table A3.1.4 Image Attributes

Section A3.2 describes the GeoTIFF format for data files.

A3.2 Importance of GeoTIFF:

Remote sensing and its applications use data in digital form. These datasets generally contain digital image along with other information which are further used for data interpretation and other applications. Different communities use these data for their required purpose. To make it convenient to the users, standards are required to store these datasets. Many image file formats like *GIF*, *PGM*, *BMP*, *JPEG* etc. are available globally. These formats have an image header with fixed fields containing information such as image dimensions, color space specification, etc.

However, these formats have no facility to store information related to geo-location of image pixels. They also do not support storage of cartographic data. Due to these limitations, a new format is required to store image data along with image geometry as well as cartographic information along with ancillary information required for further processing. The new format has to be platform independent, flexible and extensible. The Tagged Image File Format (*TIFF*) is one of the popularly available image formats. It is platform independent extensible. Several third party solutions exist for recording cartographic information using *TIFF* tags. The specifications for these tags (fields) are available in *TIFF-6.0* documents (Ref. 1). These fields contain information ranging from the most primary, like image dimensions, over the most sophisticated information like copyright, up to so-called 'private tags' or 'custom tags' that can define to hold application-specific information. The *TIFF* specification defines a framework for an image header called '*IFD*' (Image File Directory) that is essentially a flexible set of specifically those tags that the *TIFF* writer software wishes to specify.

The *TIFF* file format can be used to store and digital satellite image data, scanned aerial photos, elevation models, scanned maps and the results of many types of geographic analysis. *TIFF* is the only full-featured format in the public domain, capable of supporting extension to include geographic metadata. *GeoTIFF* implements the geographic metadata formally, using compliant *TIFF* tags and structures. A *GeoTIFF* file actually contains geographic (or cartographic) data attached as tags within the *TIFF* file. The geographic data can then be used to position the image in the correct location and geometry on the screen of a geographic information display. *GeoTIFF* is a metadata format, which provides geographic information to associate with the image data. But the *TIFF* file structure allows both the metadata and the image data to be encoded into the same file. *GeoTIFF* makes use of a public tag structure which is platform interoperable between any and all *GeoTIFF*- readers.

The *GeoTIFF* format is supported by *TIFF – 6.0*. That is, the *GeoTIFF* images conform in every way to the *TIFF* formal specifications. The tags used for the "Geo" portion of the *TIFF* format conform to the acceptable and customary use of "private" or "registered" *TIFF* tags. The *GeoTIFF* tags and definitions are considered completely to the baseline and extended *TIFF* tag definitions currently supported in *TIFF-6* by Aldus Corp.

A3.2.1 Structure of *TIFF*:

A *TIFF* file begins with an 8-byte image file header, containing the following information:

- 1.The byte order used within the file.
- 2.An arbitrary but carefully chosen number (*42*) that further identifies the file as a *TIFF* file.
- 3.The offset (in bytes) of Image File Directory (*IFD*).The directory may be at any location in the file after header but must begin on a word boundary. In particular, an image file directory may follow the image data it describes.

The block diagram of a *TIFF* file is given in fig-A3.2.1. An Image File directory (*IFD*) consist of a 2-byte count of the number of directory entries (i.e. the number of fields), followed by a sequence of 12-byte field entries, followed by a 4-byte offset of the next *IFD* or 0 if none. There must be 4-bytes of 0 after the last *IFD*. There must be at least one *IFD* in a *TIFF* file and each *IFD* must have at least one entry. The structure of *TIFF* file is depicted in fig-A3.2.1.

<i>Bytes</i>	<i>Length (bytes)</i>	<i>Description</i>
0-1	2	Byte order MM/II
2-3	2	Version Number (<i>42</i>)
4-7	4	Pointer to first <i>IFD</i>

Table-A3.2.1 *TIFF* file header block

In the *TIFF* file header first two bytes are information regarding byte order is used within the file and the legal values are “*II*” (*4949* in *Hexadecimal*) or “*MM*” (*4D4D* in *Hexadecimal*). In the “*II*” format, byte order is always from the least significant byte to the most significant byte, for both 16-bit and 32-bit integers. This is called *little-endian* byte order. In the “*MM*” format, byte order is always from most significant to least significant, for both 16-bit and 32-bit integers. This is called *big-endian* byte order.

Image File Directories (*IFDs*)

Most of the time, the next structure in the *TIFF* file, after header record will be the first *IFD* but not necessarily. This onwards any thing found using pointers. It is necessary to locate first *IFD* the file header is used. The data format of each *IFD* entry is presented in Table-A3.2.2.

In *TIFF IFD* structure the tag is a 2-byte number and it is defined by *TIFF* administrators. That identifies the field. The next two byte number represents a code indicating the type of the data for the field. The count field is 4-bytes field specifies number of values in the data field not the number of bytes. The last 4-byte in *IFD* structures are usually a pointer to the start of a data field. Sometimes this field contains actual value instead of pointer if there are data of size 4-bytes or less.

The various data type supported by the *IFD* structure is explained in detail in *TIFF* manual.

Bytes	Length (bytes)	Description
0-1	2	The tag that identifies the field
2-3	2	The field type
4-7	4	The number of values, count of the indicated type
8-11	4	Data pointer or data field

Table-A3.2.2 IFD Structure

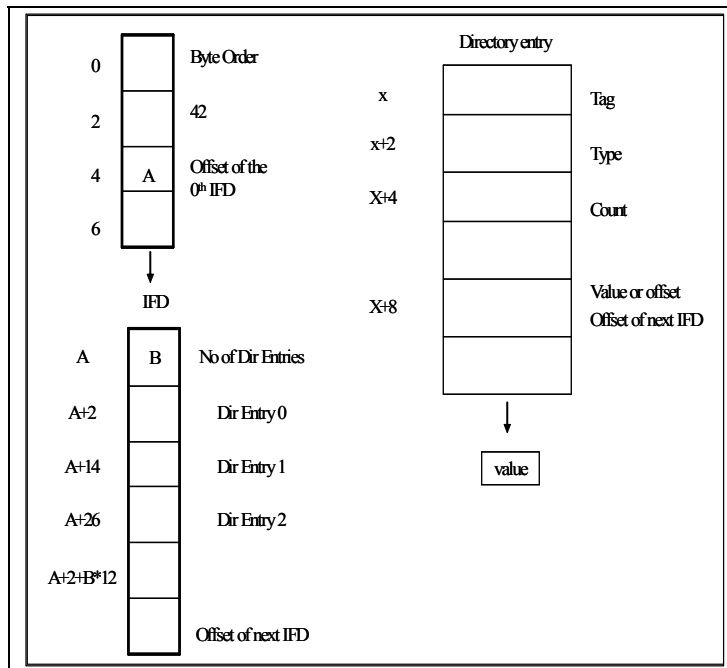

Figure-3.2.1 File structure of standard TIFF file

A3.3 GeoTIFF for RISAT-1 Data Products:

The aim of *GeoTIFF* format is to augment an existing popular raster-data format (*TIFF*) to support geographic and geocoding information associated with digital image acquired by remote sensing satellite. This format uses a “*MetaTag*” (or *GeoKey*) approach to embed

hundreds of information elements into just six tags. The quality of platform independency of *TIFF* format avoids cross-platform interchange hurdles. These keys are designed as equivalently to the standard *TIFF* tags and follows the styles of *TIFF* in their structure. As need arises new keys can be defined within the current frame work without requiring the allocation of new tags from *Aldus/adobe*.

Numerical codes are used by *GeoTIFF* to describe various entities related to geocoding of satellite image, like projection types, coordinate systems, datum, ellipsoids, etc. *GeoTIFF* requires support for all documented *TIFF-6.0* tag data types, and in particular the *IEEE* double precession floating point “*DOUBLE*” type tag. The details of other requirements are described in *GeoTIFF format specification GeoTIFF version 1.0* document (Ref. 2).

A3.3.1 *GeoTIFF* structure:

GeoTIFF file format and “*GeoKey*” data storage methodology used in *GeoTIFF* is described here in this section. A *GeoTIFF* file is *TIFF* file and inherits same the file structure as described in the corresponding portion of *TIFF* specification. Information related to *GeoTIFF* is encoded in various reserved *TIFF* tags and contains no privet Image *IFDs*. It requires several tags to represent the information related to geocoding of satellite image data. If these all parameters implemented as separate *TIFF* tags it exhausting the limited resources of the *TIFF* tag-space. To overcome this problem a *GeoTIFF* file stores various parameters in a set of keys which are virtually identical in function to a tag but has one more level of abstraction above *TIFF*. Effectively, it is a sort of “*Meta-Tag*”. The key is same like a tag, and it has an ID number ranging from 0 to 65535, but unlike *TIFF* tag all key ID are available for use in *GeoTIFF* parameter definition. *GeoTIFF* directory structure is represented by fig-A3.3.1.

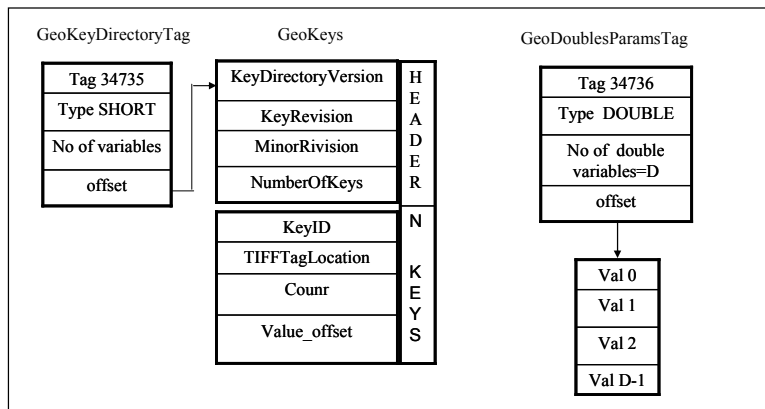

Figure- A3.3.1 *GeoTIFF* directory structure

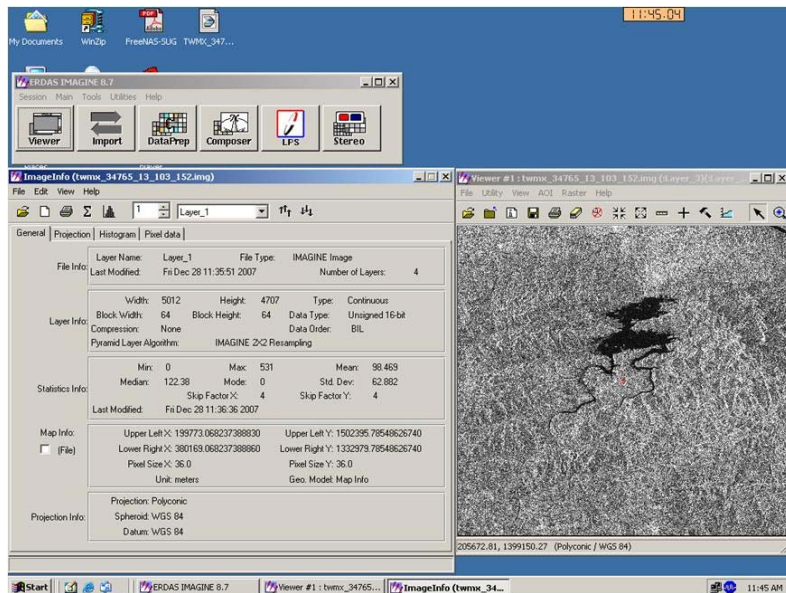

Figure-A3.3.2 Overview of *GeoTIFF* viewed by *ERDAS* Showing Geographic information related to the image

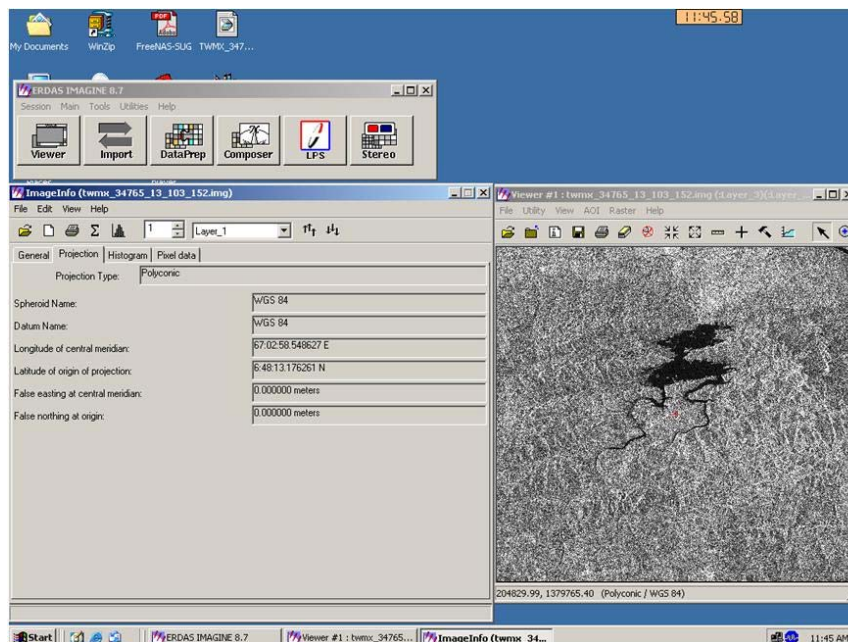

Figure-A3.3.3 overview of *GeoTIFF* viewed by *ERDAS* showing projection information

All the keys in *GeoTIFF* are also called *geoKeys*. They are all referenced from the *GeoKeyDirectoryTag* which define as follows.

GeoKeyDirectoryTag:

Tag = 34735

Type=SHORT

N= Variables, (≥ 4)

Alias: ProjectionInfoTag, CoordSystemInfoTag

Owner: SPOT Image, Inc

Like this, other GeoTIFF tag are ModelPixelScalTag (33550), GeoDoubleParameterTag (34736), GeoAsciiParamsTag (34737) etc. are used to store geocoding information.

The block diagram of a GeoTIFF file is given below:

Using above file structure one can generate *GeoTIFF* file which holds satellite image data along with geographic and geolocation information. This file can be accessed by any professional software which can understand *GeoTIFF* format. Further this data can be utilized. This file can be treated as *TIFF* file also.

A3.4 Validation of *GeoTIFF* Products.

The *GeoTIFF* image generated using *RISAT-DP* software is opened using *ERDAS IMAGINE 8.7* packages. This is presented in figure-A3.3.2 and figure-A3.3.3

Appendix-4

Scene Corner Coordinates Convention

A 4.1 DP Convention for Scene Corners Coordinates

Level - 1 Product (SLANT and GROUND GEO-TAGGED)

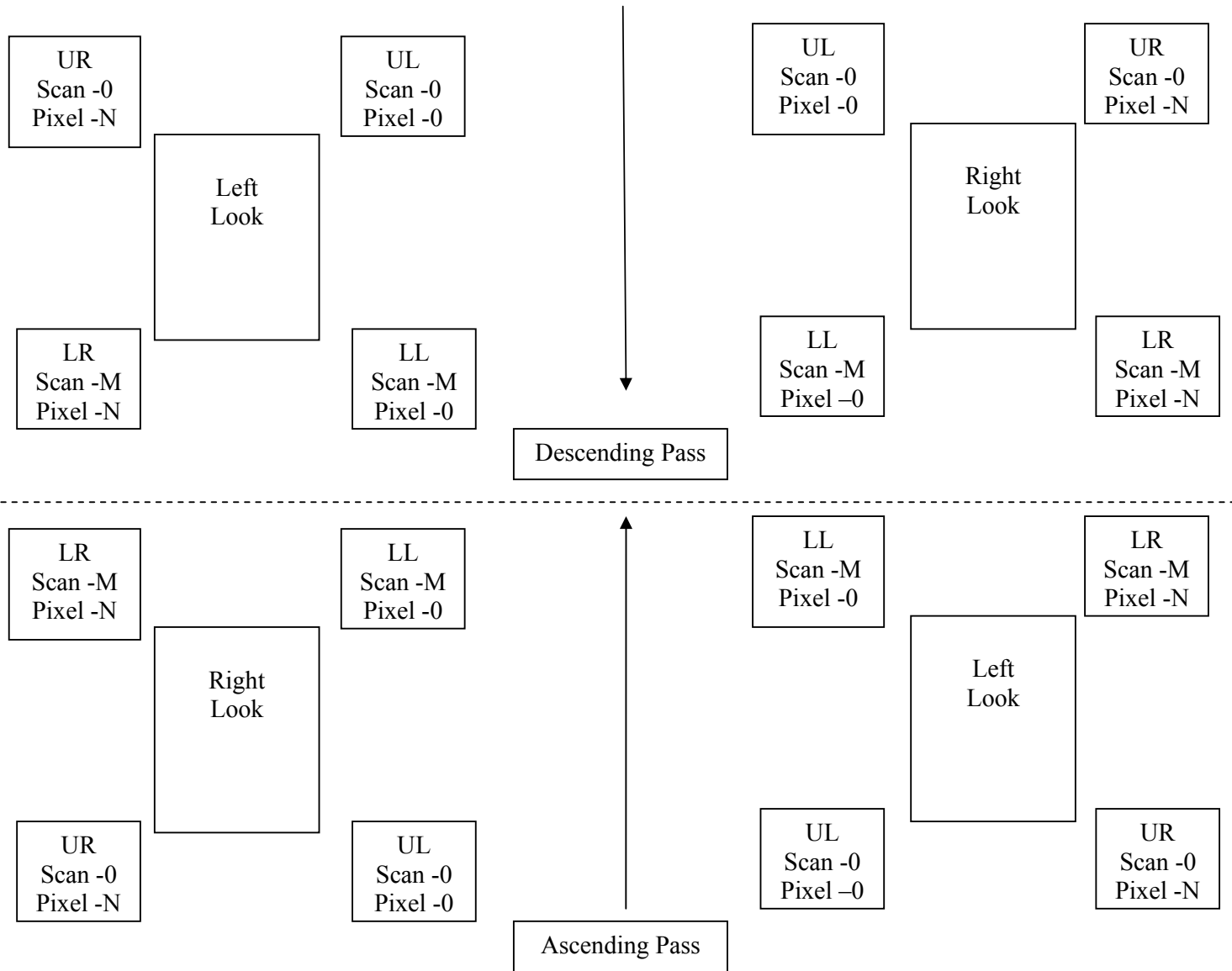

In above Figures, UL: Upper Left; UR: Upper Right; LL: Lower Left & LR: Lower Right represent the corner co-ordinates (geo-tagged) according to scene acquisition in Ascending and Descending passes in Left and Right Looks.

Level - 2 Product (TERRAIN GEO-REFERENCED)

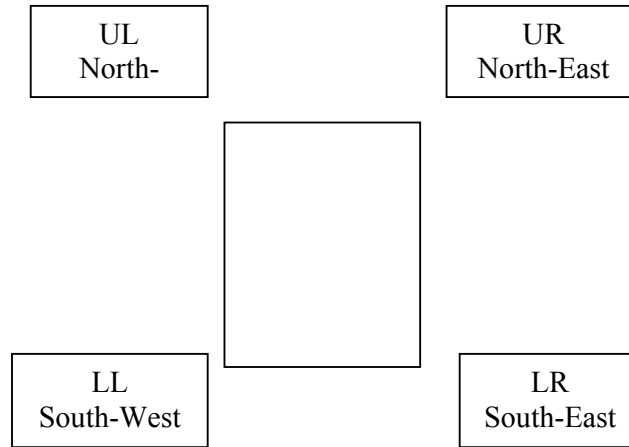

References:

1. "TIFF Revision 6.0", Adobe Developers Association, JPL 03 June 1992. <ftp://ftp.adobe.com/pub/adobe/DeveloperSupport/TechNotes/PDFfiles>.
2. "GeoTIFF format specification Tiff revision 1.0", Niles Ritter, JPL 10 Nov 1995.
3. RISAT Data Format VER-12, 19th March 2012, Space Applications Centre (ISRO)

Enquiries to Designers:

S.No.	Name	Division	E-Mail Address	Contact No.s
1.	Raghav Mehra	AIPD/DPSG/SIPA	raghavmehra@sac.isro.gov.in mehra.rahav@gmail.com	+91 79- 26916237 +91 79 - 26916285
2.	Kirti Padia	AIPD/DPSG/SIPA	kirtipadia@sac.isro.gov.in kirtipadia@yahoo.com	+91 79- 26914151 +91 79 - 26914153